

Best choice.

Cutting. Bending. Automation.

Bystronic

Bystronic Kalıplar RF-AC Kalıplarımız

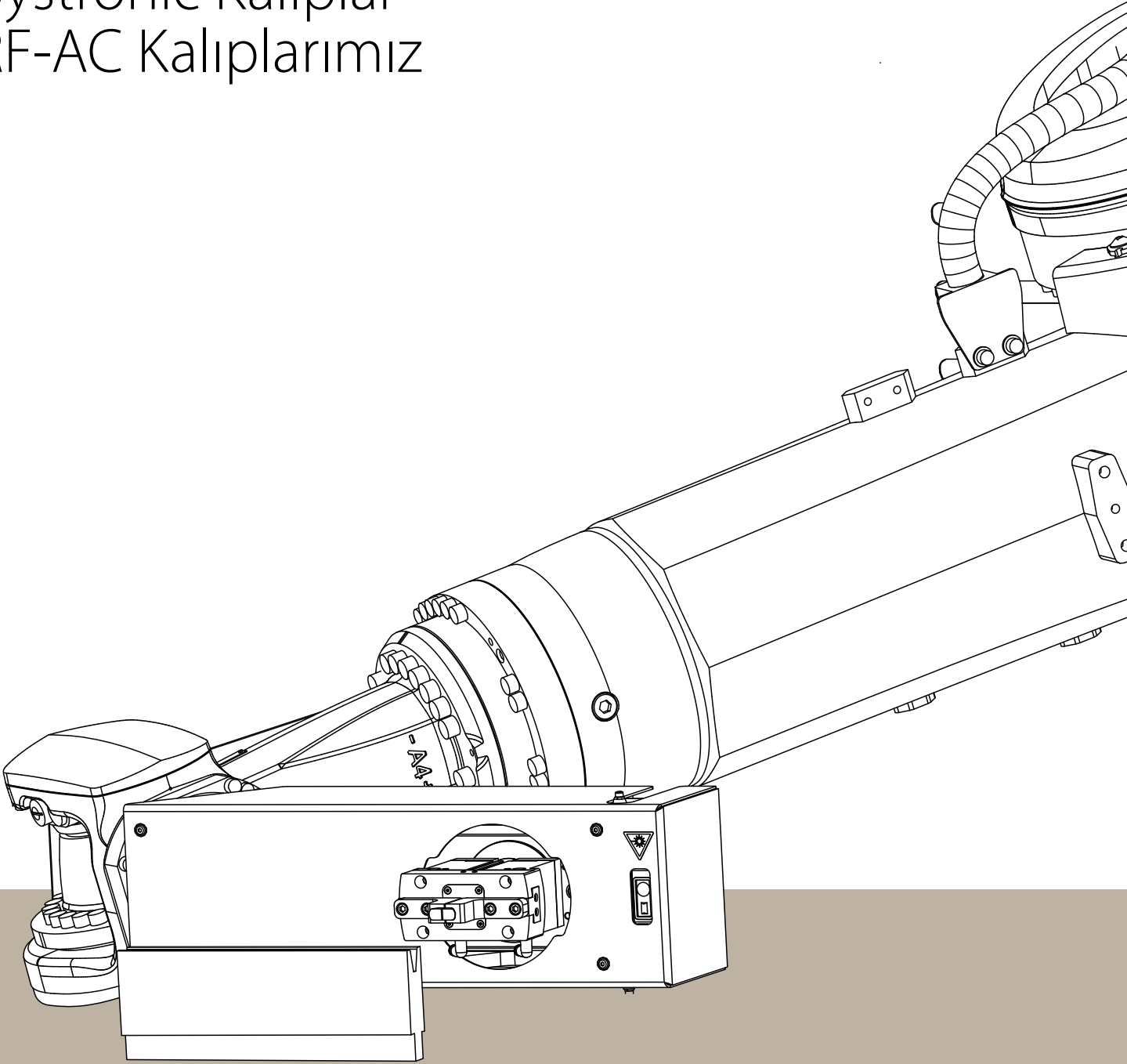



İçindekiler

Temeller	3
Bu katalogdaki simgeler.....	3
Havalı bükme için hesaplama temelleri.....	4
Kalıp deęiřtirme nasıl çalıřır?.....	8
Çentikler.....	9
Segmentasyonlar	10
Üst kalıplar.....	14
Üst kalıp segmentleri.....	16
Alt kalıplar	22
Alt tabla seenekleri	24
Alt kalıp segmentasyonu.....	25
Katlama kalıpları	60
Dünya genelinde irtibat bilgileri	70



Temeller

Bu katalogdaki simgeler



sertlik: 58 - 62 HRC



izin verilen maks. yük



azami kutu derinliği



ağırlık



ters çevrilebilir kalıp

Bu katalogda aşağıdaki makineler ele alınmaktadır:

Xpert Tool Changer - XTC

Modular Tool Changer - MTC

Bending Cell - BC



Havalı bükme için hesaplama temelleri

Havalı bükme için kapasite şeması

Verilen veriler $R_m = 420 \text{ N/mm}^2$ çekme mukavemetine sahip bir malzemenin 1 m uzunluğunda bükülmesi baz alınarak hesaplanmıştır.

V	6	8	10	12	16	18	20	24	32	40	50	60	80
R	1	1,2	1,6	2	2,5	2,8	3	3,5	5	6	8	9,5	12
t	F	Bükme kuvveti, kN/1 m bükme uzunluğu											
a	Minimum flanş uzunluğu, mm												
0,5	25												
	4,3												
0,8	70	48											
	4,6	5,7											
1	115	80	60										
	5	6	7										
1,2		120	90	70									
		6	7,5	8,5									
1,5			150	120									
			8	9									
2,0				235	160	135	120	95					
				10	12	13	14,5	17					
2,5					265	225	200	155	110				
					12,5	14	15,5	17,5	23				
3,0							300	240	165	125			
							15,5	17,5	23,5	28			
4,0									315	235	180		
									25	29	35		
5,0									535	430	310	250	
									26	31	35,5	43	
6,0										610	450	360	
										32	36	44	
8,0											880	690	470
											40	46	57
10													800
													60
12													1200
													62
16													
18													
20													

Tufalli saclar bükme kuvvetini 1,05–1,1 oranında artıracaktır



100	120	130	140	150	160	180	190	200	230	260	290	320	V
15,5	19	21	23	24,5	26	28	30	32	36	40	45	50	R
F	Bükme kuvveti, kN/1 m bükme uzunluğu												t
a	Minimum flanş uzunluğu, mm												
													0,5
													0,8
													1
													1,2
													1,5
													2,0
													2,5
													3,0
													4,0
													5,0
													6,0
360													8,0
71													10
600	470	430	390										12
71	85	92	100										16
900	710	650	580	550	500								18
73	86	92	100	105	115								20
	1400	1250	1150	1050	950	810	800	710	600				
	90	98	105	110	115	130	135	140	160				
			1480	1350	1250	1100	1000	950	800	700	600		
			105	110	120	130	135	140	160	180	205		
						1400	1300	1200	1000	900	850	700	
						135	140	145	165	180	205	225	

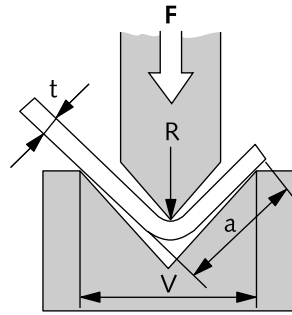

İç radyüs R kalıp açıklığı V'nin yaklaşık %16'sına karşılık gelir.



Havalı bükme için hesaplama temelleri

Hesaplama formülleri

Havalı bükme için önerilen alt kalıp açıklığı

Malzeme kalınlığı	t	0,5–2,5 mm	3–8 mm	9–10 mm	> 12 mm
Alt kalıp açıklığı	V	6 × t	8 × t	10 × t	12 × t

Aşağıdakiler için bükme kuvveti

Alüminyum	Rm = 300 N/mm ²	F = F (tablo) × 0,65
Alaşımız çelik	Rm = 420 N/mm ²	F = F (tablo)
Paslanmaz çelik	Rm = 700 N/mm ²	F = F (tablo) × 1,6

Havalı bükme için bükme kuvvetinin belirlenmesi (referans veriler)

$$F = \frac{R_m \times t^2}{V} \times \left(1 + \frac{4 \times t}{V}\right)$$

Çevrim: Rm = gerilme direnci, N/mm²

10 N = 1 Kg

10 kN = 1 t

Minimum iç radyüs R için çevrim

kalınlık t	1	2	3	4	5	6	8	10	12	16	18	20
min. R	1	2	3	5	6	8	12	16	20	28	36	40



Gerilme direnci

Malzeme		Gerilme direnci	
Amerikan	Avrupa	KPSI	N/mm ²
6061 Alüminyum	Alu 50	42	290
5052 Alüminyum	Alu 35	44	303
1010 Alaşimsız çelik	DC01	53	366
A536-80 G 60-40-18	GGG-40	58	400
A 351 G CF 8	G-X 6CrNi 18 9	65	450
A 572 G50	S 355 MC	80	550
Domex 80	S 420 MC	80	550
A 36	S 235 JR	80	552
304 Paslanmaz	Inox V2A	85	586
316 Paslanmaz	Inox V4A	87	600
A 572 G 65	S 460 MC	95	655
Domex 100	S 500 MC	102	700
Domex 550	S 550 MC	110	760
Domex 600	S 600 MC	119	820
Weldox 700	Weldox 700	123	850
Domex 650	S 650 MC	128	880
Domex 700	S 700 MC	138	950
4140 Düşük alaşımlı	42 CrMo 4	145	1000
Weldox 900	Weldox 900	149	1030
Weldox 960	Weldox 960	154	1060
Hardox 400	Hardox 400	181	1250
Hardox 500	Hardox 500	225	1550

Yüksek mukavemetli malzemelerin bükülmesi için lütfen danışmanınızla irtibata geçin.



Kalıp deęiřtirme nasıl alıřır?

Hızlı ve hassas kalıp deęiřtirme iin akıllı otomasyon

- Alt ve üst kalıpların otomatik olarak deęiřtirilmesi sayesinde zamandan tasarruf edin ve büküm kalitesini artırın
- Büyük kalıplarda bile (V80'e kadar / BC ve MTC V120'ye kadar) üst ve alt kiriřlerin baęlama sisteminde kalıp setlerinin hassas ve hatasız konumlandırılması
- Herhangi bir zamanda basit kalıp geniřletme: Akıllı sensör teknolojisi, yeni kalıpları otomatik olarak algılar ve bunları kalıp magazinine entegre eder
- Üst kalıpların otomatik dönüşü, bükme uygulamalarının çeřitlilięini artırır
- Tüm kalıplar makine iinde hazır tutulduęundan yüksek derecede ergonomi ve kompakt kullanım
- Bükme tablasının otomatik temizlięi sayesinde bükülmüş paraların hassas ve özenli iřlenmesi



* Azami kalıp aęırlıęı:

Gripper XTC - azami 15,0 kg

Gripper BC/MTC - azami 25,0 kg



Çentikler

Üst kalıplar

Üst kalıpların arka tarafında çentikler vardır. Asimetrik pançların, örn. P4 ve P5'in de önlerinde çentikler vardır.

250 mm yüksekliğinde P2, P3, P4, P5, P6, P7, P8, P9, P11 ve P900 tipi pançların elleçlenmesi mümkündür. İstek üzerine 350 mm yükseklikte kalıplar hazırlanabilir.

Segmentasyonlar, 30 mm'den başlar ve 515 mm'ye kadar gider*.

Alt kalıplar

Alt kalıpların arka tarafında bir çentik vardır. Bu, robot için kalıpları elleçlemesini mümkün kılan şeydir.

V6'dan V120'ye kadar Kalıp giriş parçaları mümkündür**.

Segmentasyon uzunlukları, 50 mm'den başlar ve 515 mm'ye kadar gider*.



* Yaklaşık 515 mm'lik parçalar talep üzerine veya BC/MTC'de edinilebilir

** V80'e kadar olan kalıp giriş parçaları XTC tarafından elleçlenebilir
V120'e kadar olan kalıp giriş parçaları BC/MTC tarafından elleçlenebilir



Segmentasyonlar

Xpert Tool Changer, MTC ve BC için geçerli

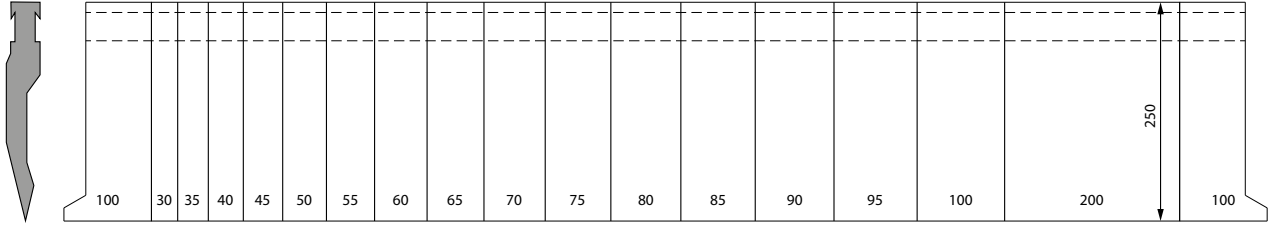

Üst kalıplar	Parça numarası
Panç P2 RF-AC/85° H=250 L=1375 kes.	65208.0002.5000
Panç P4 RF-AC/85° H=250 L=1375 kes.	65208.0004.5000
Panç P5 RF-AC/30° H=250 L=1375 kes.	65208.0005.5000
Panç P7 RF-AC/30° H=250 L=1375 kes.	65208.0007.5000

Tüm segmentasyonlar aşağıdaki uzunluklardan oluşur:

30 mm, 35 mm, 40 mm, 45 mm, 50 mm, 55 mm, 60 mm, 65 mm, 70 mm, 75 mm, 80 mm, 85 mm, 90 mm, 95 mm, 100 mm, 200 mm, korna seti 100 mm LH + RH

Üst kalıplar	Parça numarası
Panç P11 RF-AC B=20 H=250 L=1175 kes.	65208.0011.5000

Segmentasyonlar aşağıdaki uzunluklardan oluşur:

30 mm, 35 mm, 40 mm, 45 mm, 50 mm, 55 mm, 60 mm, 65 mm, 70 mm, 75 mm, 80 mm, 85 mm, 90 mm, 95 mm, 100 mm, 200 mm

Alt kalıplar	Parça numarası
Kalıp giriş parçası V-Flat B40 L=1025 kes.	65208.0000.5000

Segmentasyonlar aşağıdaki uzunluklardan oluşur:

50 mm, 55 mm, 60 mm, 65 mm, 70 mm, 75 mm, 80 mm, 85 mm, 90 mm, 95 mm, 100 mm, 200 mm



50	55	60	65	70	75	80	85	90	95	100	200

Alt kalıplar		Parça numarası
Kalıp giriş parçası V6C/30°	L=1025 kes.	64208.0006.5000
Kalıp giriş parçası V8C/30°	L=1025 kes.	64208.0008.5000
Kalıp giriş parçası V10C/30°	L=1025 kes.	64208.0010.5000
Kalıp giriş parçası V12C/30°	L=1025 kes.	64208.0012.5000
Kalıp giriş parçası V16C/30°	L=1025 kes.	64208.0020.5000
Kalıp giriş parçası V20C/30°	L=1025 kes.	64208.0020.5000
Kalıp giriş parçası V24C/30°	L=1025 kes.	64208.0024.5000
Kalıp giriş parçası V32C/30°	L=1025 kes.	64208.0032.5000
Kalıp giriş parçası V40C/60°	L=1025 kes.	64208.0040.5000
Kalıp giriş parçası V50C/60°	L=1025 kes.	64208.0050.5000
Kalıp giriş parçası V60C/60°	L=1025 kes.	64208.0060.5000
Kalıp giriş parçası V80C/80°	L=1025 kes.	64208.0080.5000
Kalıp giriş parçası V100C/80°	L=1025 kes.	64208.0100.5000
Kalıp giriş parçası V120C/80°	L=1025 kes.	64208.0120.5000
Kalıp giriş parçası V6SC/30°	L=1025 kes.	64208.0006.5100
Kalıp giriş parçası V8SC/30°	L=1025 kes.	64208.0008.5100
Kalıp giriş parçası V10SC/30°	L=1025 kes.	64208.0010.5100
Kalıp giriş parçası V12SC/30°	L=1025 kes.	64208.0012.5100

Tüm segmentasyonlar aşağıdaki uzunluklardan oluşur:

50 mm, 55 mm, 60 mm, 65 mm, 70 mm, 75 mm, 80 mm, 85 mm, 90 mm, 95 mm, 100 mm, 200 mm

*** V80'e kadar olan alt kalıplar XTC için geçerlidir**
V120'ye kadar olan alt kalıplar BC / MTC için geçerlidir



Segmentasyonlar



50	55	60	65	70	75	80	85	90	95	100	200

Alt kalıplar	Parça numarası
Kalıp giriş parçası V6C/30° H=100 L=1025 kes.	64208.0006.5031
Kalıp giriş parçası V8C/30° H=100 L=1025 kes.	64208.0008.5165
Kalıp giriş parçası V10C/30° H=100 L=1025 kes.	64208.0010.5031
Kalıp giriş parçası V12C/30° H=100 L=1025 kes.	64208.0012.5030
Kalıp giriş parçası V16C/30° H=100 L=1025 kes.	64208.0020.5040
Kalıp giriş parçası V20C/30° H=100 L=1025 kes.	64208.0020.5030
Kalıp giriş parçası V24C/30° H=100 L=1025 kes.	64208.0024.5031
Kalıp giriş parçası V32C/30° H=100 L=1025 kes.	64208.0032.5030
Kalıp giriş parçası V40C/60° H=100 L=1025 kes.	64208.0040.5030
Kalıp giriş parçası V50C/60° H=100 L=1025 kes.	64208.0050.5030
Kalıp giriş parçası V60C/60° H=100 L=1025 kes.	64208.0060.5030
Kalıp giriş parçası V80C/80° H=100 L=1025 kes.	64208.0080.5030

Tüm segmentasyonlar aşağıdaki uzunluklardan oluşur:

50 mm, 55 mm, 60 mm, 65 mm, 70 mm, 75 mm, 80 mm, 85 mm, 90 mm, 95 mm, 100 mm, 200 mm

*** V80'e kadar olan alt kalıplar XTC için geçerlidir**
V120'ye kadar olan alt kalıplar BC / MTC için geçerlidir

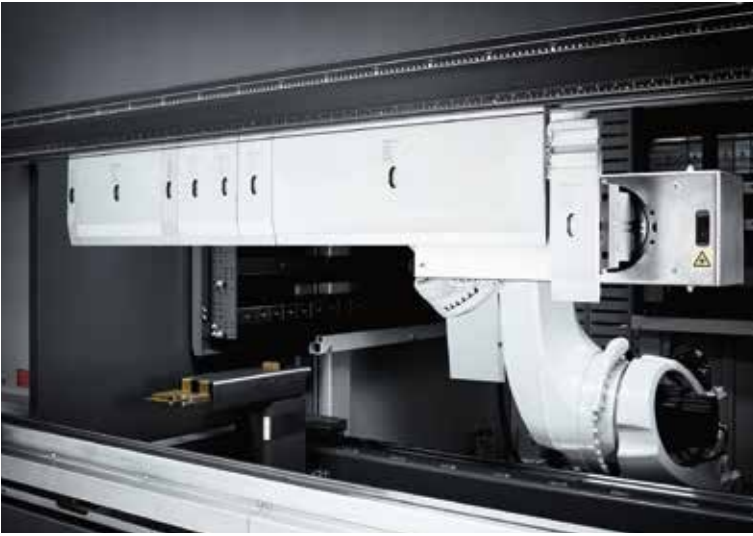



Üst kalıplar

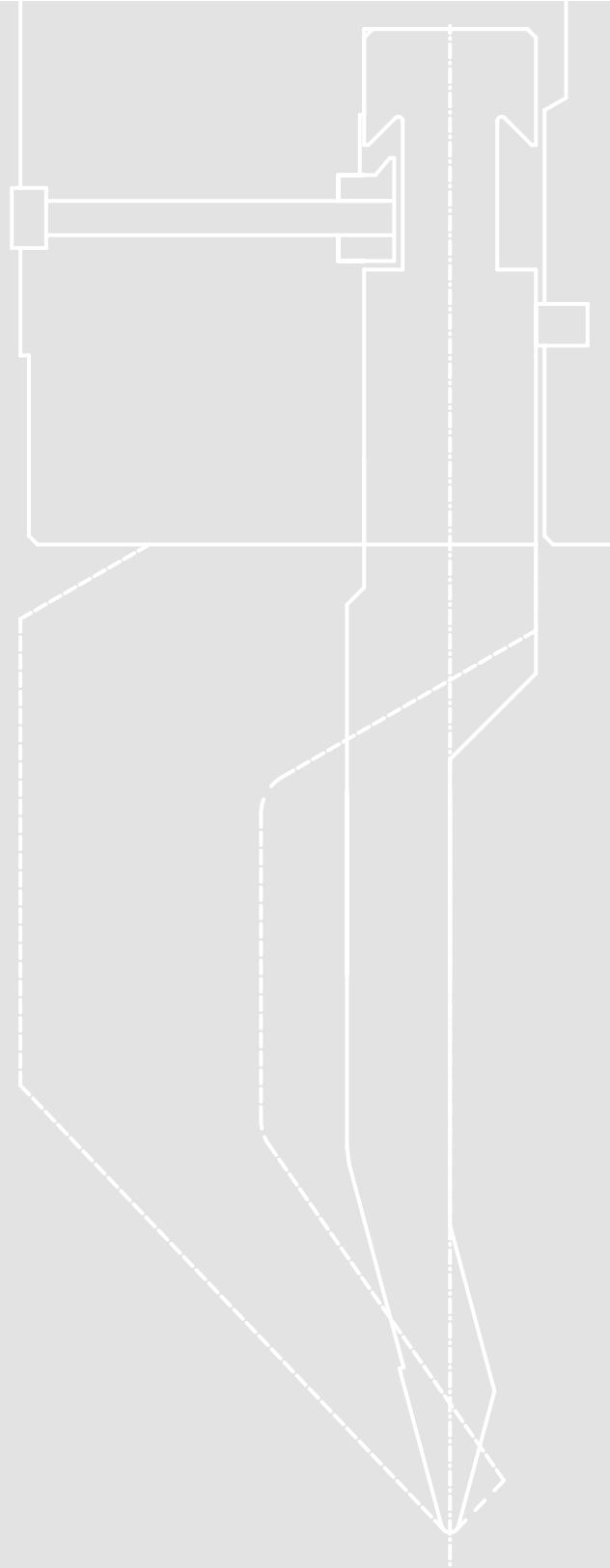

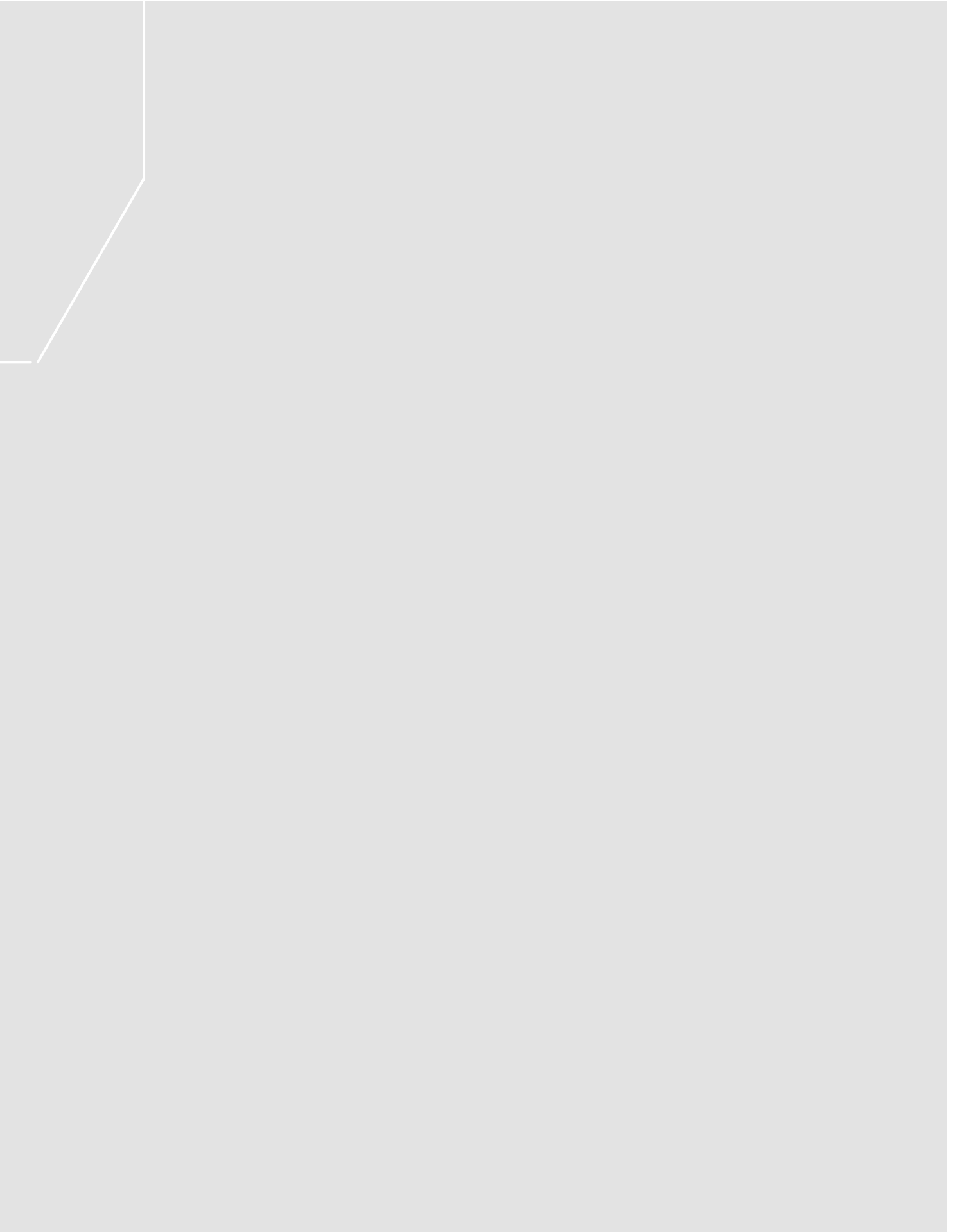



Üst kalıp segmentleri

Kornalar RF-AC

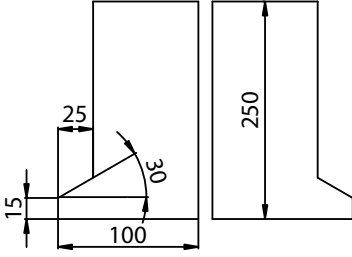

Panç RF-AC L = 1375 kes.

(30+35+40+45+50+60+65+70+75+80+85+90+95+100+200 +kornalar l+r)

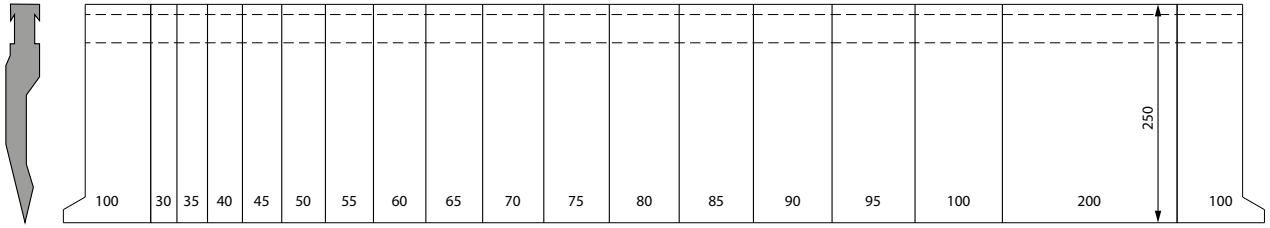

Talep üzerine özel segmentasyonlar.

Diğer radyüslü tüm üst kalıplar talep üzerine hazırlanabilir.

Azami kalıp ağırlığı:

Gripper XTC - maks. 15,0 kg

Gripper BC/MTC - maks. 25,0 kg



Modular Tool Changer



Bending Cell





P2 RF-AC/85° H250

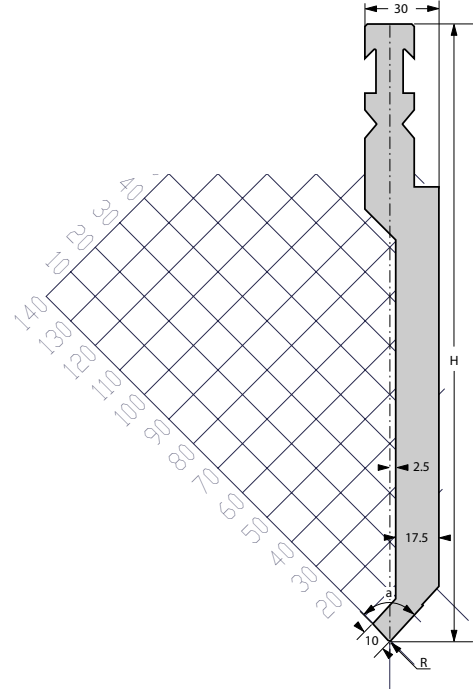

[R] Radyüs (mm)*	1,0
Burun açısı	85°
[H] Yükseklik (mm)	250

*diğer radyüs talep üzerine

Standart uzunluk	Parça numarası
30 mm	65208.0002.5001
35 mm	65208.0002.5002
40 mm	65208.0002.5003
45 mm	65208.0002.5004
50 mm	65208.0002.5005
55 mm	65208.0002.5006
60 mm	65208.0002.5007
65 mm	65208.0002.5008
70 mm	65208.0002.5015
75 mm	65208.0002.5016
80 mm	65208.0002.5017

Standart uzunluk	Parça numarası
85 mm	65208.0002.5018
90 mm	65208.0002.5019
95 mm	65208.0002.5020
100 mm	65208.0002.5011
200 mm	65208.0002.5012
275 mm	65208.0002.5013
300 mm	65208.0002.5014
515 mm	65208.0002.5019
Korna seti LH + RH	65208.0002.7001
Korna LH	65208.0002.7002
Korna RH	65208.0002.7003



F maks = 1000 kN/m



34,4 kg/m



98,0 mm



P4 RF-AC/85° H250

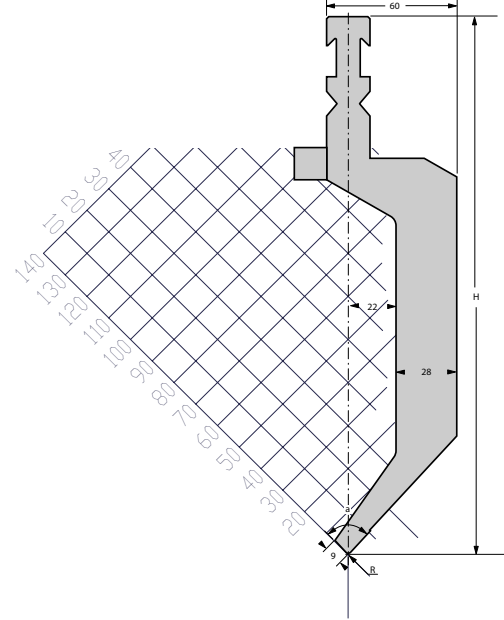

[R] Radyüs (mm)*	1,5
Burun açısı	85°
[H] Yükseklik (mm)	250

*diğer radyüs talep üzerine

Standart uzunluk	Parça numarası
30 mm	65208.0004.5001
35 mm	65208.0004.5002
40 mm	65208.0004.5003
45 mm	65208.0004.5004
50 mm	65208.0004.5005
55 mm	65208.0004.5006
60 mm	65208.0004.5007
65 mm	65208.0004.5008
70 mm	65208.0004.5015
75 mm	65208.0004.5016
80 mm	65208.0004.5017

Standart uzunluk	Parça numarası
85 mm	65208.0004.5018
90 mm	65208.0004.5019
95 mm	65208.0004.5020
100 mm	65208.0004.5011
200 mm	65208.0004.5012
275 mm	65208.0004.5013
300 mm	65208.0004.5014
Korna seti LH + RH	65208.0004.7003
Korna LH	65208.0004.7001
Korna RH	65208.0004.7002



F maks = 600 kN/m



48,3 kg/m



98,0 mm



P5 RF-AC/30° H250

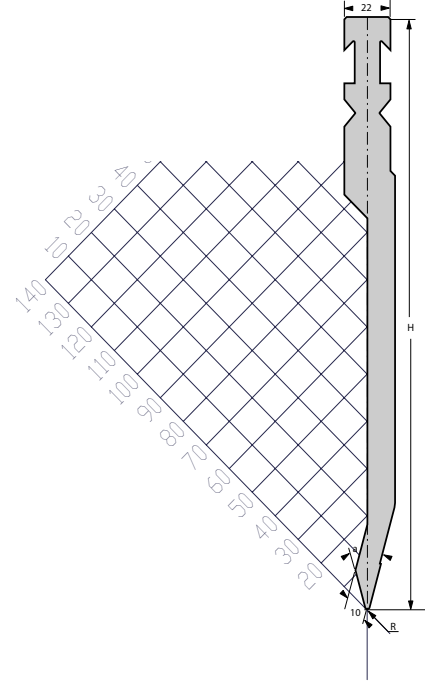

[R] Radyüs (mm)*	1
Burun açısı	30°
[H] Yükseklik (mm)	250

*diğer radyüs talep üzerine

Standart uzunluk	Parça numarası
30 mm	65208.0005.5001
35 mm	65208.0005.5002
40 mm	65208.0005.5003
45 mm	65208.0005.5004
50 mm	65208.0005.5005
55 mm	65208.0005.5006
60 mm	65208.0005.5007
65 mm	65208.0005.5008
70 mm	65208.0005.5015
75 mm	65208.0005.5016
80 mm	65208.0005.5017

Standart uzunluk	Parça numarası
85 mm	65208.0005.5018
90 mm	65208.0005.5019
95 mm	65208.0005.5020
100 mm	65208.0005.5011
200 mm	65208.0005.5012
275 mm	65208.0005.5013
300 mm	65208.0005.5014
515 mm	65208.0005.5021
Korna seti LH + RH	65208.0005.7003
Korna LH	65208.0005.7001
Korna RH	65208.0005.7002



F maks = 750 kN/m



26,0 kg/m



98,0 mm



P7 RF-AC/30° H250

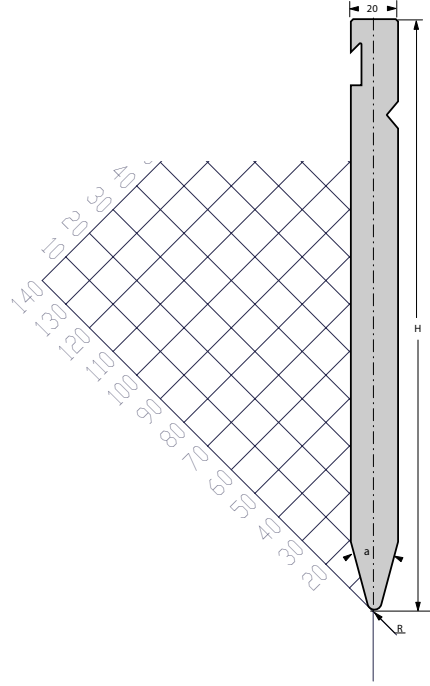

[R] Radyüs (mm)*	3
Burun açısı	30°
[H] Yükseklik (mm)	250

*diğer radyüs talep üzerine

Standart uzunluk	Parça numarası
30 mm	65208.0007.5001
35 mm	65208.0007.5002
40 mm	65208.0007.5003
45 mm	65208.0007.5004
50 mm	65208.0007.5005
55 mm	65208.0007.5006
60 mm	65208.0007.5007
65 mm	65208.0007.5008
70 mm	65208.0007.5015
75 mm	65208.0007.5016
80 mm	65208.0007.5017

Standart uzunluk	Parça numarası
85 mm	65208.0007.5018
90 mm	65208.0007.5019
95 mm	65208.0007.5020
100 mm	65208.0007.5011
200 mm	65208.0007.5012
275 mm	65208.0007.5013
300 mm	65208.0007.5014
515 mm	65208.0007.5026
Korna seti LH + RH	65208.0007.7003
Korna LH	65208.0007.7001
Korna RH	65208.0007.7002



F maks = 1400 kN/m



35,9 kg/m



98,0 mm



Alt kalıplar

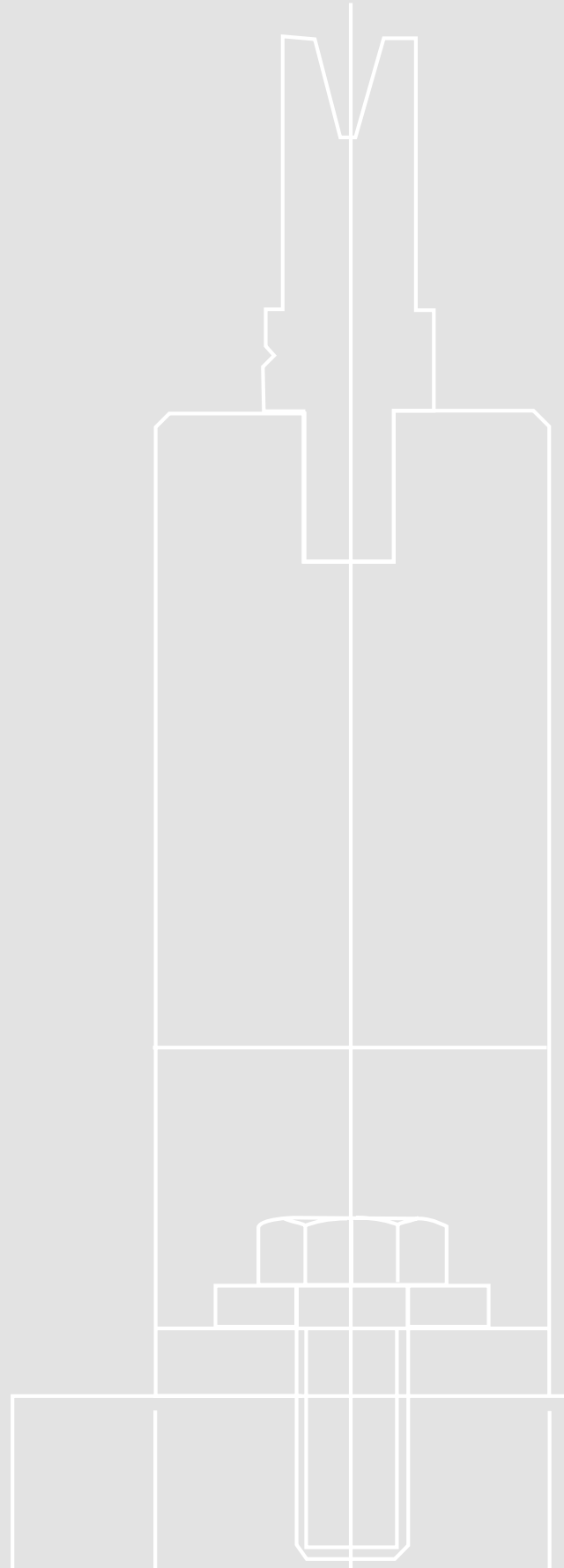





Alt tabla seçenekleri

Hidrolik kalıp bağlamalı tabla

T12

(Opsiyonel Xpert 60 - 320 ve
Xpert 250 - 1000)

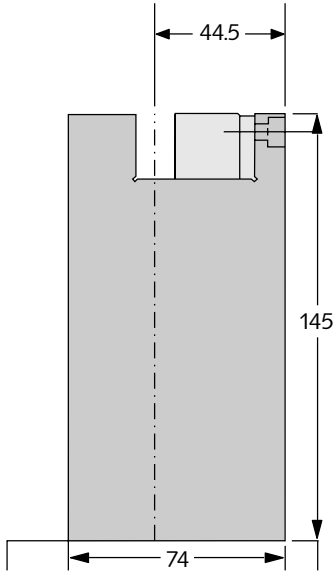

T13

(Opsiyonel Xpert 60 - 320 ve
Xpert 250 - 1000)

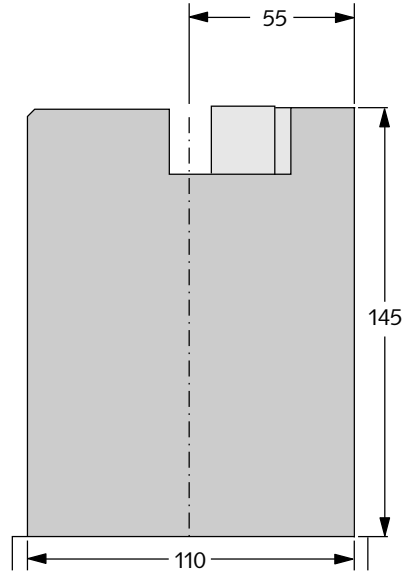



Alt kalıp segmentasyonu

Kalıp giriş parçası VC L = 1025 kes.

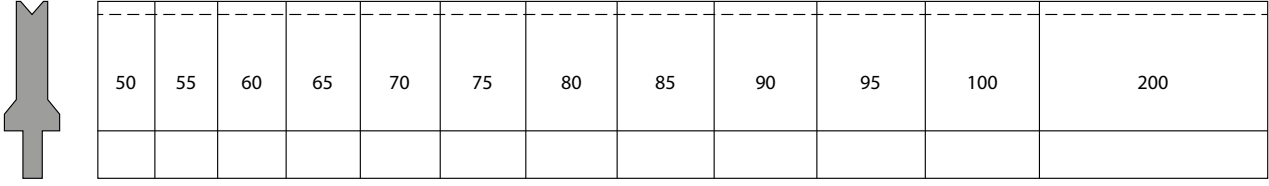

The diagram shows a vertical mold part with a notch at the top. To its right is a table with 12 columns and 2 rows. The top row contains the values 50, 55, 60, 65, 70, 75, 80, 85, 90, 95, 100, and 200. The bottom row is empty.

50	55	60	65	70	75	80	85	90	95	100	200

Talep üzerine özel segmentasyon.

Ek olarak tüm alt kalıplar farklı bir radyüs, kalıp açısı ve yüksekliği (standart olmayan) ile tedarik edilebilir.



V6C/30° H55

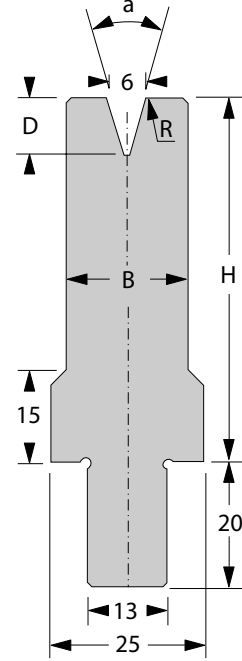

[R] Radyüs (mm)*	0,75
[a] V - Açısı	30°
[H] Yükseklik (mm)	55

[B] Genişlik (mm)	20
[D] Derinlik (mm)	9,3

*diğer radyüs talep üzerine

Standart uzunluk	Parça numarası
50 mm	64208.0006.5001
55 mm	64208.0006.5002
60 mm	64208.0006.5003
65 mm	64208.0006.5004
70 mm	64208.0006.5005
75 mm	64208.0006.5006
80 mm	64208.0006.5007
85 mm	64208.0006.5008
90 mm	64208.0006.5009
95 mm	64208.0006.5010
100 mm	64208.0006.5011

Standart uzunluk	Parça numarası
200 mm	64208.0006.5012
275 mm	64208.0006.5013
300 mm	64208.0006.5014
515 mm	64208.0006.5015
1025 mm kes.	64208.0006.5000



F maks 30° = 400 kN/m



10,9 kg/m



Kalıp giriş parçası 13 mm



V6C/30° H100

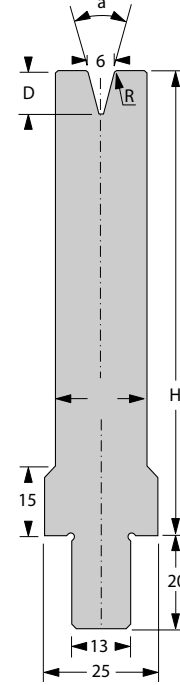

[R] Radyüs (mm)*	0,75
[a] V - Açısı	30°
[H] Yükseklik (mm)	100

[B] Genişlik (mm)	20
[D] Derinlik (mm)	9,3

*diğer radyüs talep üzerine

Standart uzunluk	Parça numarası
50 mm	64208.0006.5016
55 mm	64208.0006.5017
60 mm	64208.0006.5018
65 mm	64208.0006.5019
70 mm	64208.0006.5020
75 mm	64208.0006.5021
80 mm	64208.0006.5022
85 mm	64208.0006.5023
90 mm	64208.0006.5024
95 mm	64208.0006.5025
100 mm	64208.0006.5026

Standart uzunluk	Parça numarası
200 mm	64208.0006.5027
275 mm	64208.0006.5028
300 mm	64208.0006.5029
515 mm	64208.0006.5030
1025 mm kes.	64208.0006.5031



F maks 30° = 400 kN/m



18,0 kg/m



Kalıp giriş parçası 13 mm



V8C/30° H55

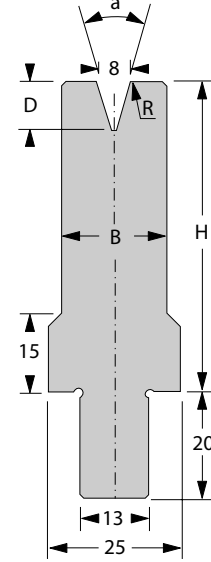

[R] Radyüs (mm)*	1
[a] V - Açısı	30°
[H] Yükseklik (mm)	55

[B] Genişlik (mm)	20
[D] Derinlik (mm)	11,2

*diğer radyüs talep üzerine

Standart uzunluk	Parça numarası
50 mm	64208.0008.5001
55 mm	64208.0008.5002
60 mm	64208.0008.5003
65 mm	64208.0008.5004
70 mm	64208.0008.5005
75 mm	64208.0008.5006
80 mm	64208.0008.5007
85 mm	64208.0008.5008
90 mm	64208.0008.5009
95 mm	64208.0008.5010
100 mm	64208.0008.5011

Standart uzunluk	Parça numarası
200 mm	64208.0008.5012
275 mm	64208.0008.5013
300 mm	64208.0008.5014
515 mm	64208.0008.5015
1025 mm kes.	64208.0008.5000



F maks 30° = 400 kN/m



10,8 kg/m



Kalıp giriş parçası 13 mm



V8C/30° H100

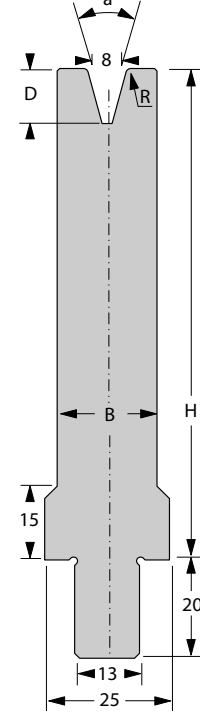

[R] Radyüs (mm)*	1
[a] V - Açısı	30°
[H] Yükseklik (mm)	100

[B] Genişlik (mm)	20
[D] Derinlik (mm)	11,2

*diğer radyüs talep üzerine

Standart uzunluk	Parça numarası
50 mm	64208.0008.5016
55 mm	64208.0008.5017
60 mm	64208.0008.5018
65 mm	64208.0008.5019
70 mm	64208.0008.5020
75 mm	64208.0008.5021
80 mm	64208.0008.5022
85 mm	64208.0008.5023
90 mm	64208.0008.5024
95 mm	64208.0008.5025
100 mm	64208.0008.5026

Standart uzunluk	Parça numarası
200 mm	64208.0008.5027
275 mm	64208.0008.5028
300 mm	64208.0008.5029
515 mm	64208.0008.5030
1025 mm kes.	64208.0008.5165



F maks 30° = 300 kN/m



17,8 kg/m



Kalıp giriş parçası 13 mm



V10C/30° H55

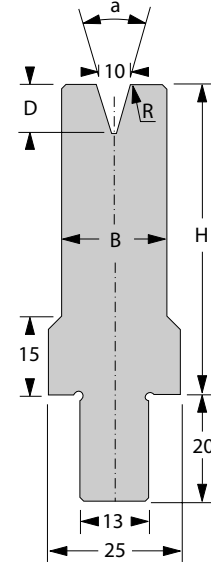

[R] Radyüs (mm)*	1
[a] V - Açısı	30°
[H] Yükseklik (mm)	55

[B] Genişlik (mm)	20
[D] Derinlik (mm)	14,9

*diğer radyüs talep üzerine

Standart uzunluk	Parça numarası
50 mm	64208.0010.5001
55 mm	64208.0010.5002
60 mm	64208.0010.5003
65 mm	64208.0010.5004
70 mm	64208.0010.5005
75 mm	64208.0010.5006
80 mm	64208.0010.5007
85 mm	64208.0010.5008
90 mm	64208.0010.5009
95 mm	64208.0010.5010
100 mm	64208.0010.5011

Standart uzunluk	Parça numarası
200 mm	64208.0010.5012
275 mm	64208.0010.5013
300 mm	64208.0010.5014
515 mm	64208.0010.5015
1025 mm kes.	64208.0010.5000



F maks 30° = 200 kN/m



10,6 kg/m



Kalıp giriş parçası 13 mm



V10C/30° H100

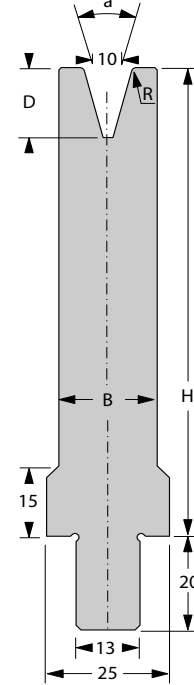

[R] Radyüs (mm)*	1
[a] V - Açısı	30°
[H] Yükseklik (mm)	100

[B] Genişlik (mm)	20
[D] Derinlik (mm)	14,9

*diğer radyüs talep üzerine

Standart uzunluk	Parça numarası
50 mm	64208.0010.5016
55 mm	64208.0010.5017
60 mm	64208.0010.5018
65 mm	64208.0010.5019
70 mm	64208.0010.5020
75 mm	64208.0010.5021
80 mm	64208.0010.5022
85 mm	64208.0010.5023
90 mm	64208.0010.5024
95 mm	64208.0010.5025
100 mm	64208.0010.5026

Standart uzunluk	Parça numarası
200 mm	64208.0010.5027
275 mm	64208.0010.5028
300 mm	64208.0010.5029
515 mm	64208.0010.5030
1025 mm kes.	64208.0010.5031



F maks 30° = 200 kN/m



17,6 kg/m



Kalıp giriş parçası 13 mm



V12C/30° H55

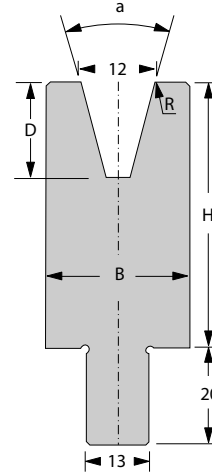

[R] Radyüs (mm)*	1,5
[a] V - Açısı	30°
[H] Yükseklik (mm)	55

[B] Genişlik (mm)	25
[D] Derinlik (mm)	18,6

*diğer radyüs talep üzerine

Standart uzunluk	Parça numarası
50 mm	64208.0012.5001
55 mm	64208.0012.5002
60 mm	64208.0012.5003
65 mm	64208.0012.5004
70 mm	64208.0012.5005
75 mm	64208.0012.5006
80 mm	64208.0012.5007
85 mm	64208.0012.5008
90 mm	64208.0012.5009
95 mm	64208.0012.5010
100 mm	64208.0012.5011

Standart uzunluk	Parça numarası
200 mm	64208.0012.5012
275 mm	64208.0012.5013
300 mm	64208.0012.5014
515 mm	64208.0012.5015
1025 mm kes.	64208.0012.5000



F maks 30° = 250 kN/m



11,8 kg/m



Kalıp giriş parçası 13 mm



V12C/30° H100

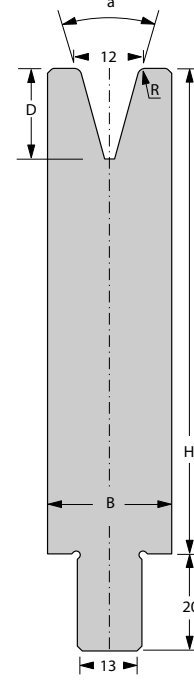

[R] Radyüs (mm)*	1,5
[a] V - Açısı	30°
[H] Yükseklik (mm)	100

[B] Genişlik (mm)	25
[D] Derinlik (mm)	18,6

*diğer radyüs talep üzerine

Standart uzunluk	Parça numarası
50 mm	64208.0012.5017
55 mm	64208.0012.5018
60 mm	64208.0012.5019
65 mm	64208.0012.5020
70 mm	64208.0012.5021
75 mm	64208.0012.5022
80 mm	64208.0012.5023
85 mm	64208.0012.5024
90 mm	64208.0012.5025
95 mm	64208.0012.5026
100 mm	64208.0012.5027

Standart uzunluk	Parça numarası
200 mm	64208.0012.5028
275 mm	64208.0012.5029
300 mm	64208.0012.5016
515 mm	64208.0012.5031
1025 mm kes.	64208.0012.5030



F maks 30° = 250 kN/m



20,6 kg/m



Kalıp giriş parçası 13 mm



V16C/30° H55

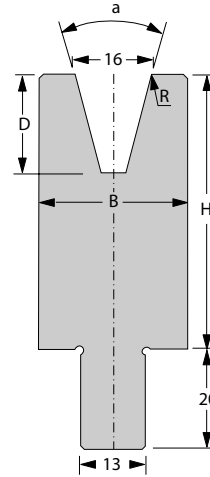

[R] Radyüs (mm)*	2
[a] V - Açısı	30°
[H] Yükseklik (mm)	55

[B] Genişlik (mm)	30
[D] Derinlik (mm)	20,5

*diğer radyüs talep üzerine

Standart uzunluk	Parça numarası
50 mm	64208.0016.5001
55 mm	64208.0016.5002
60 mm	64208.0016.5003
65 mm	64208.0016.5004
70 mm	64208.0016.5005
75 mm	64208.0016.5006
80 mm	64208.0016.5007
85 mm	64208.0016.5008
90 mm	64208.0016.5009
95 mm	64208.0016.5010
100 mm	64208.0016.5011

Standart uzunluk	Parça numarası
200 mm	64208.0016.5012
275 mm	64208.0016.5013
300 mm	64208.0016.5014
515 mm	64208.0016.5015
1025 mm kes.	64208.0016.5000



F maks 30° = 250 kN/m



13,3 kg/m



Kalıp giriş parçası 13 mm



V16C/30° H100

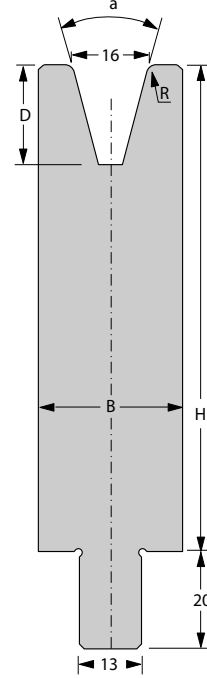

[R] Radyüs (mm)*	2
[a] V - Açısı	30°
[H] Yükseklik (mm)	100

[B] Genişlik (mm)	30
[D] Derinlik (mm)	20,5

*diğer radyüs talep üzerine

Standart uzunluk	Parça numarası
50 mm	64208.0016.5016
55 mm	64208.0016.5017
60 mm	64208.0016.5018
65 mm	64208.0016.5019
70 mm	64208.0016.5020
75 mm	64208.0016.5021
80 mm	64208.0016.5022
85 mm	64208.0016.5023
90 mm	64208.0016.5024
95 mm	64208.0016.5025
100 mm	64208.0016.5026

Standart uzunluk	Parça numarası
200 mm	64208.0016.5027
275 mm	64208.0016.5028
300 mm	64208.0016.5029
515 mm	64208.0016.5030
1025 mm kes.	64208.0016.5040



F maks 30° = 250 kN/m



23,9 kg/m



Kalıp giriş parçası 13 mm



V20C/30° H55

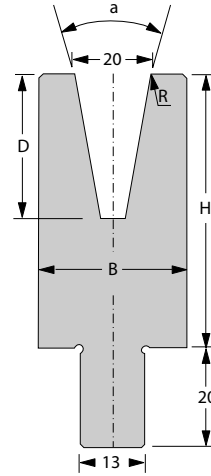

[R] Radyüs (mm)*	2,5
[a] V - Açısı	30°
[H] Yükseklik (mm)	55

[B] Genişlik (mm)	30
[D] Derinlik (mm)	28

*diğer radyüs talep üzerine

Standart uzunluk	Parça numarası
50 mm	64208.0020.5001
55 mm	64208.0020.5002
60 mm	64208.0020.5003
65 mm	64208.0020.5004
70 mm	64208.0020.5005
75 mm	64208.0020.5006
80 mm	64208.0020.5007
85 mm	64208.0020.5008
90 mm	64208.0020.5009
95 mm	64208.0020.5010
100 mm	64208.0020.5011

Standart uzunluk	Parça numarası
200 mm	64208.0020.5012
275 mm	64208.0020.5013
300 mm	64208.0020.5014
515 mm	64208.0020.5015
1025 mm kes.	64208.0020.5000



F maks 30° = 150 kN/m



12,2 kg/m



Kalıp giriş parçası 13 mm



V20C/30° H100

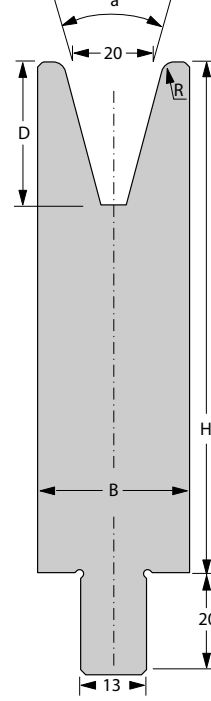

[R] Radyüs (mm)*	2,5
[a] V - Açısı	30°
[H] Yükseklik (mm)	100

[B] Genişlik (mm)	30
[D] Derinlik (mm)	28

*diğer radyüs talep üzerine

Standart uzunluk	Parça numarası
50 mm	64208.0020.5017
55 mm	64208.0020.5018
60 mm	64208.0020.5019
65 mm	64208.0020.5020
70 mm	64208.0020.5021
75 mm	64208.0020.5022
80 mm	64208.0020.5023
85 mm	64208.0020.5024
90 mm	64208.0020.5025
95 mm	64208.0020.5026
100 mm	64208.0020.5027

Standart uzunluk	Parça numarası
200 mm	64208.0020.5028
275 mm	64208.0020.5029
300 mm	64208.0020.5016
515 mm	64208.0020.5031
1025 mm kes.	64208.0020.5030



F maks 30° = 150 kN/m



22,8 kg/m



Kalıp giriş parçası 13 mm



V24C/30° H55

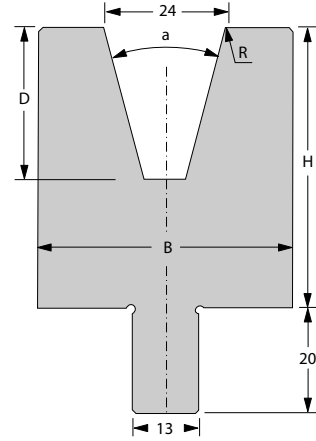

[R] Radyüs (mm)*	3
[a] V - Açısı	30°
[H] Yükseklik (mm)	55

[B] Genişlik (mm)	40
[D] Derinlik (mm)	29,8

*diğer radyüs talep üzerine

Standart uzunluk	Parça numarası
50 mm	64208.0024.5001
55 mm	64208.0024.5002
60 mm	64208.0024.5003
65 mm	64208.0024.5004
70 mm	64208.0024.5005
75 mm	64208.0024.5006
80 mm	64208.0024.5007
85 mm	64208.0024.5008
90 mm	64208.0024.5009
95 mm	64208.0024.5010
100 mm	64208.0024.5011

Standart uzunluk	Parça numarası
200 mm	64208.0024.5012
275 mm	64208.0024.5013
300 mm	64208.0024.5014
515 mm	64208.0024.5015
1025 mm kes.	64208.0024.5000



F maks 30° = 300 kN/m



15,5 kg/m



Kalıp giriş parçası 13 mm



V24C/30° H100

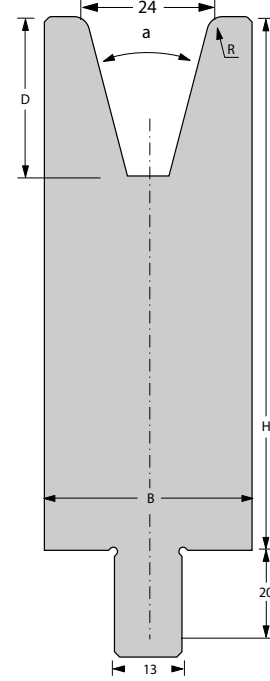

[R] Radyüs (mm)*	3
[a] V - Açısı	30°
[H] Yükseklik (mm)	100

[B] Genişlik (mm)	40
[D] Derinlik (mm)	29,8

*diğer radyüs talep üzerine

Standart uzunluk	Parça numarası
50 mm	64208.0024.5016
55 mm	64208.0024.5017
60 mm	64208.0024.5018
65 mm	64208.0024.5019
70 mm	64208.0024.5020
75 mm	64208.0024.5021
80 mm	64208.0024.5022
85 mm	64208.0024.5023
90 mm	64208.0024.5024
95 mm	64208.0024.5025
100 mm	64208.0024.5026

Standart uzunluk	Parça numarası
200 mm	64208.0024.5027
275 mm	64208.0024.5028
300 mm	64208.0024.5029
515 mm	64208.0024.5030
1025 mm kes.	64208.0024.5031



F maks 30° = 300 kN/m



29,6 kg/m



Kalıp giriş parçası 13 mm



V32C/30° H55

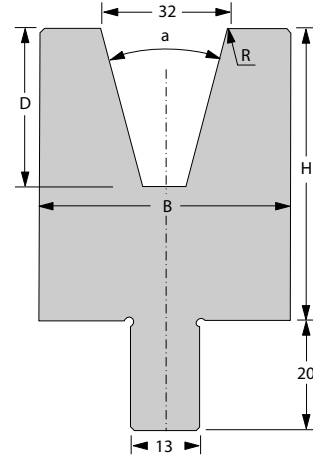
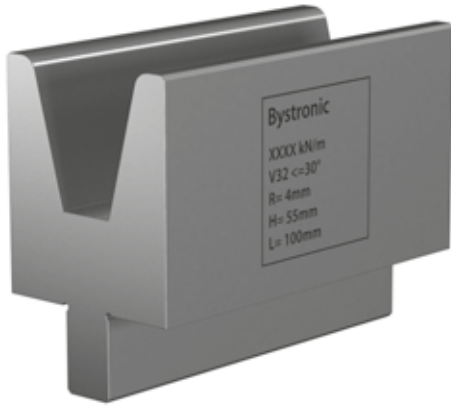

[R] Radyüs (mm)*	4
[a] V - Açısı	30°
[H] Yükseklik (mm)	55

[B] Genişlik (mm)	48
[D] Derinlik (mm)	33,6

*diğer radyüs talep üzerine

Standart uzunluk	Parça numarası
50 mm	64208.0032.5001
55 mm	64208.0032.5002
60 mm	64208.0032.5003
65 mm	64208.0032.5004
70 mm	64208.0032.5005
75 mm	64208.0032.5006
80 mm	64208.0032.5007
85 mm	64208.0032.5008
90 mm	64208.0032.5009
95 mm	64208.0032.5010
100 mm	64208.0032.5011

Standart uzunluk	Parça numarası
200 mm	64208.0032.5012
275 mm	64208.0032.5013
300 mm	64208.0032.5014
515 mm	64208.0032.5015
1025 mm kes.	64208.0032.5000



F maks 30° = 300 kN/m



16,7 kg/m



Kalıp giriş parçası 13 mm



V32C/30° H100

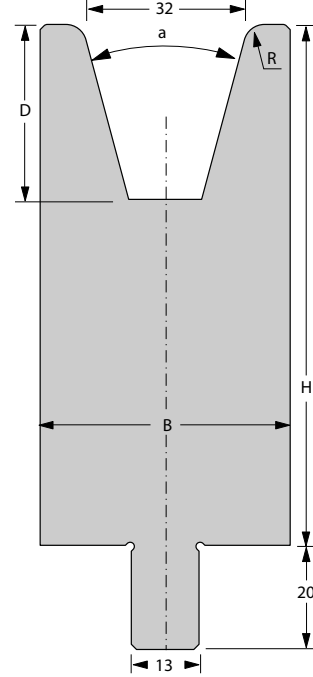

[R] Radyüs (mm)*	4
[a] V - Açısı	30°
[H] Yükseklik (mm)	100

[B] Genişlik (mm)	48
[D] Derinlik (mm)	33,6

*diğer radyüs talep üzerine

Standart uzunluk	Parça numarası
50 mm	64208.0032.5017
55 mm	64208.0032.5018
60 mm	64208.0032.5019
65 mm	64208.0032.5020
70 mm	64208.0032.5021
75 mm	64208.0032.5022
80 mm	64208.0032.5023
85 mm	64208.0032.5024
90 mm	64208.0032.5025
95 mm	64208.0032.5026
100 mm	64208.0032.5027

Standart uzunluk	Parça numarası
200 mm	64208.0032.5028
275 mm	64208.0032.5029
300 mm	64208.0032.5016
515 mm	64208.0032.5031
1025 mm kes.	64208.0032.5030



F maks 30° = 300 kN/m



33,7 kg/m



Kalıp giriş parçası 13 mm



V40C/60° H55

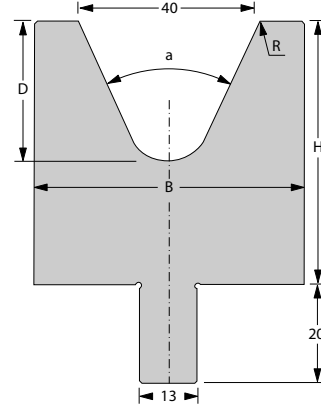
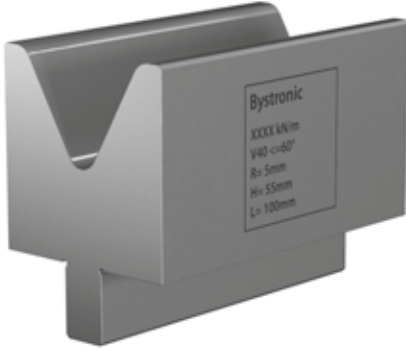

[R] Radyüs (mm)*	5
[a] V - Açısı	60°
[H] Yükseklik (mm)	55

[B] Genişlik (mm)	55
[D] Derinlik (mm)	29,6

*diğer radyüs talep üzerine

Standart uzunluk	Parça numarası
50 mm	64208.0040.5001
55 mm	64208.0040.5002
60 mm	64208.0040.5003
65 mm	64208.0040.5004
70 mm	64208.0040.5005
75 mm	64208.0040.5006
80 mm	64208.0040.5007
85 mm	64208.0040.5008
90 mm	64208.0040.5009
95 mm	64208.0040.5010
100 mm	64208.0040.5011

Standart uzunluk	Parça numarası
200 mm	64208.0040.5012
275 mm	64208.0040.5013
300 mm	64208.0040.5014
515 mm	64208.0040.5015
1025 mm kes.	64208.0040.5000



F maks 60° = 1800 kN/m



20,5 kg/m



Kalıp giriş parçası 13 mm



V40C/60° H100

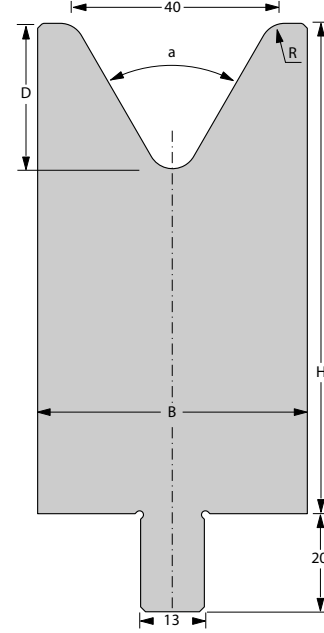

[R] Radyüs (mm)*	5
[a] V - Açısı	60°
[H] Yükseklik (mm)	100

[B] Genişlik (mm)	55
[D] Derinlik (mm)	29,6

*diğer radyüs talep üzerine

Standart uzunluk	Parça numarası
50 mm	64208.0040.5017
55 mm	64208.0040.5018
60 mm	64208.0040.5019
65 mm	64208.0040.5020
70 mm	64208.0040.5021
75 mm	64208.0040.5022
80 mm	64208.0040.5023
85 mm	64208.0040.5024
90 mm	64208.0040.5025
95 mm	64208.0040.5026
100 mm	64208.0040.5027

Standart uzunluk	Parça numarası
200 mm	64208.0040.5028
275 mm	64208.0040.5029
300 mm	64208.0040.5016
515 mm	64208.0040.5031
1025 mm kes.	64208.0040.5030



F maks 60° = 1300 kN/m



39,9 kg/m



Kalıp giriş parçası 13 mm



V50C/60° H55

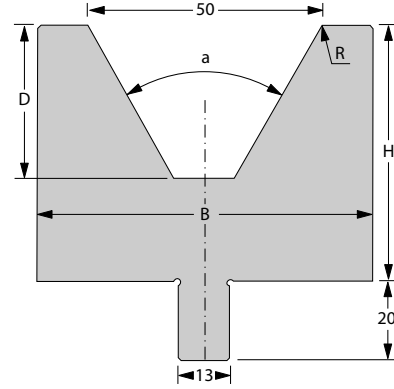
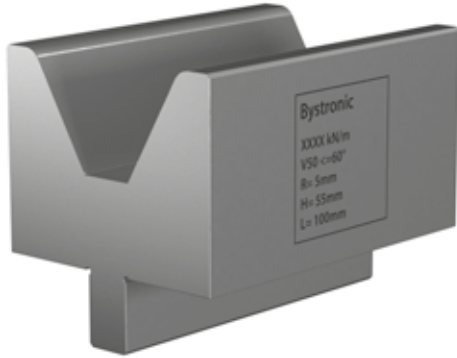

[R] Radyüs (mm)*	5
[a] V - Açısı	60°
[H] Yükseklik (mm)	55

[B] Genişlik (mm)	70
[D] Derinlik (mm)	30,3

*diğer radyüs talep üzerine

Standart uzunluk	Parça numarası
50 mm	64208.0050.5001
55 mm	64208.0050.5002
60 mm	64208.0050.5003
65 mm	64208.0050.5004
70 mm	64208.0050.5005
75 mm	64208.0050.5006
80 mm	64208.0050.5007
85 mm	64208.0050.5008
90 mm	64208.0050.5009
95 mm	64208.0050.5010
100 mm	64208.0050.5011

Standart uzunluk	Parça numarası
200 mm	64208.0050.5012
275 mm	64208.0050.5013
300 mm	64208.0050.5014
515 mm	64208.0050.5015
1025 mm kes.	64208.0050.5000



F maks 60° = 1200 kN/m



24,5 kg/m



Kalıp giriş parçası 13 mm



V50C/60° H100

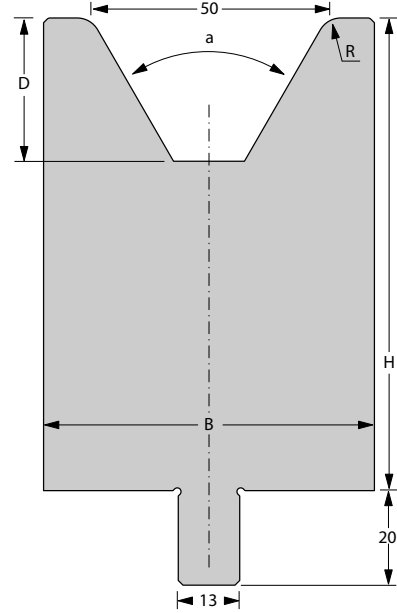

[R] Radyüs (mm)*	5
[a] V - Açısı	60°
[H] Yükseklik (mm)	100

[B] Genişlik (mm)	70
[D] Derinlik (mm)	30,3

*diğer radyüs talep üzerine

Standart uzunluk	Parça numarası
50 mm	64208.0050.5016
55 mm	64208.0050.5017
60 mm	64208.0050.5018
65 mm	64208.0050.5019
70 mm	64208.0050.5020
75 mm	64208.0050.5021
80 mm	64208.0050.5022
85 mm	64208.0050.5023
90 mm	64208.0050.5024
95 mm	64208.0050.5025
100 mm	64208.0050.5026

Standart uzunluk	Parça numarası
200 mm	64208.0050.5027
275 mm	64208.0050.5028
300 mm	64208.0050.5029
515 mm	64208.0050.5031
1025 mm kes.	64208.0050.5030



F maks 60° = 2000 kN/m



49,2 kg/m



Kalıp giriş parçası 13 mm



V60C/60° H65

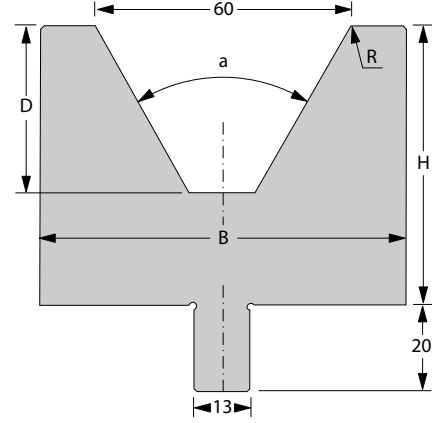

[R] Radyüs (mm)*	7
[a] V - Açısı	60°
[H] Yükseklik (mm)	65

[B] Genişlik (mm)	80
[D] Derinlik (mm)	39

*diğer radyüs talep üzerine

Standart uzunluk	Parça numarası
50 mm	64208.0060.5001
55 mm	64208.0060.5002
60 mm	64208.0060.5003
65 mm	64208.0060.5004
70 mm	64208.0060.5005
75 mm	64208.0060.5006
80 mm	64208.0060.5007
85 mm	64208.0060.5008
90 mm	64208.0060.5009
95 mm	64208.0060.5010
100 mm	64208.0060.5011

Standart uzunluk	Parça numarası
200 mm	64208.0060.5012
275 mm	64208.0060.5013
300 mm	64208.0060.5014
515 mm	64208.0060.5031
1025 mm kes.	64208.0060.5000



F maks 60° = 1600 kN/m



31,4 kg/m



Kalıp giriş parçası 13 mm



V60C/60° H100

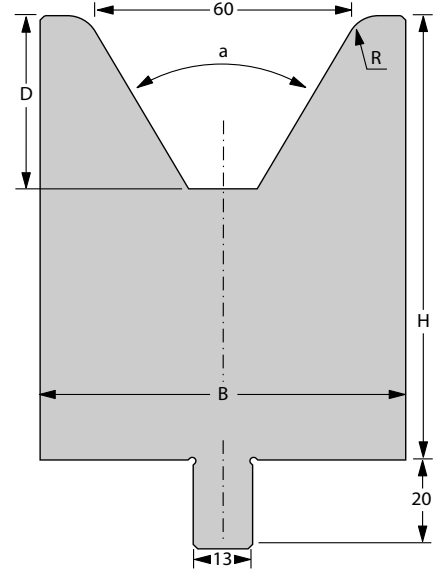

[R] Radyüs (mm)*	7
[a] V - Açısı	60°
[H] Yükseklik (mm)	100

[B] Genişlik (mm)	80
[D] Derinlik (mm)	39

*diğer radyüs talep üzerine

Standart uzunluk	Parça numarası
50 mm	64208.0060.5016
55 mm	64208.0060.5017
60 mm	64208.0060.5018
65 mm	64208.0060.5019
70 mm	64208.0060.5020
75 mm	64208.0060.5021
80 mm	64208.0060.5022
85 mm	64208.0060.5023
90 mm	64208.0060.5024
95 mm	64208.0060.5025
100 mm	64208.0060.5026

Standart uzunluk	Parça numarası
200 mm	64208.0060.5015
275 mm	64208.0060.5027
300 mm	64208.0060.5028
1025 mm kes.	64208.0060.5030



F maks 60° = 2000 kN/m



53,4 kg/m



Kalıp giriş parçası 13 mm



V80C/80° H65

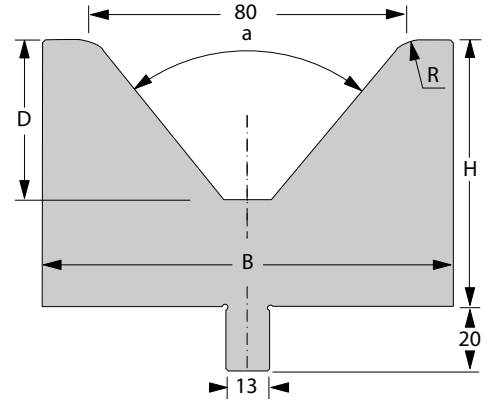
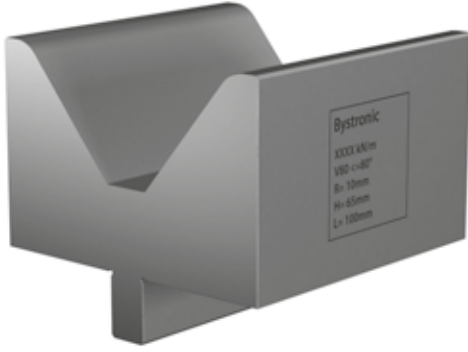

[R] Radyüs (mm)*	10
[a] V - Açısı	80°
[H] Yükseklik (mm)	65

[B] Genişlik (mm)	100
[D] Derinlik (mm)	38,7

*diğer radyüs talep üzerine

Standart uzunluk	Parça numarası
50 mm	64208.0080.5001
55 mm	64208.0080.5002
60 mm	64208.0080.5003
65 mm	64208.0080.5004
70 mm	64208.0080.5005
75 mm	64208.0080.5006
80 mm	64208.0080.5007
85 mm	64208.0080.5008
90 mm	64208.0080.5009
95 mm	64208.0080.5010
100 mm	64208.0080.5011

Standart uzunluk	Parça numarası
200 mm	64208.0080.5012
275 mm	64208.0080.5013
300 mm	64208.0080.5014
515 mm	64208.0080.5029
1025 mm kes.	64208.0080.5000



F maks 80° = 1400 kN/m



38,6 kg/m



Kalıp giriş parçası 13 mm



V80C/80° H100

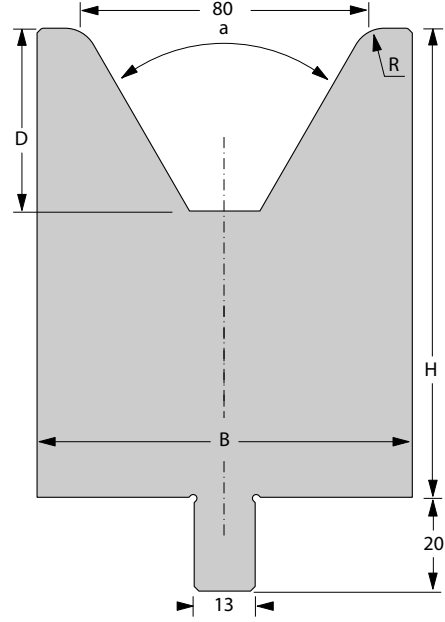

[R] Radyüs (mm)*	10
[a] V - Açısı	80°
[H] Yükseklik (mm)	100

[B] Genişlik (mm)	100
[D] Derinlik (mm)	38,7

*diğer radyüs talep üzerine

Standart uzunluk	Parça numarası
50 mm	64208.0080.5015
55 mm	64208.0080.5016
60 mm	64208.0080.5017
65 mm	64208.0080.5018
70 mm	64208.0080.5019
75 mm	64208.0080.5020
80 mm	64208.0080.5021
85 mm	64208.0080.5022
90 mm	64208.0080.5023
95 mm	64208.0080.5024
100 mm	64208.0080.5025

Standart uzunluk	Parça numarası
200 mm	64208.0080.5026
275 mm	64208.0080.5027
300 mm	64208.0080.5028
1025 mm kes.	64208.0080.5030



F maks 80° = 1400 kN/m



66,0 kg/m



Kalıp giriş parçası 13 mm



V100C/80° H85

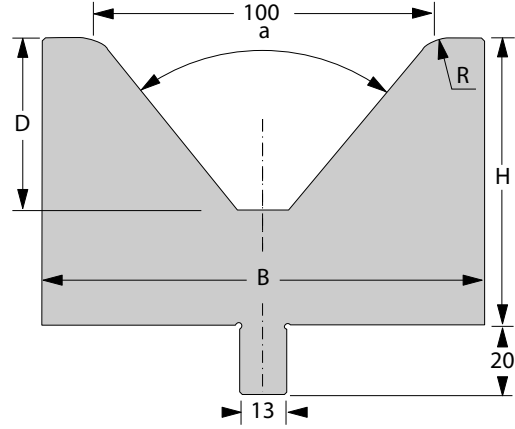
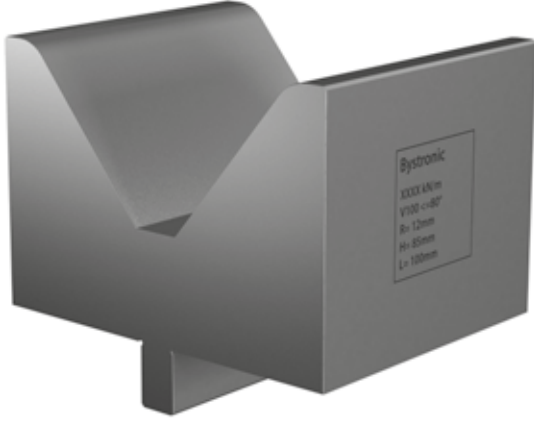

[R] Radyüs (mm)*	12
[a] V - Açısı	80°
[H] Yükseklik (mm)	85

[B] Genişlik (mm)	125
[D] Derinlik (mm)	50,5

*diğer radyüs talep üzerine

Standart uzunluk	Parça numarası
50 mm	64208.0100.5001
55 mm	64208.0100.5002
60 mm	64208.0100.5003
65 mm	64208.0100.5004
70 mm	64208.0100.5005
75 mm	64208.0100.5006
80 mm	64208.0100.5007
85 mm	64208.0100.5008
90 mm	64208.0100.5009
95 mm	64208.0100.5010
100 mm	64208.0100.5011

Standart uzunluk	Parça numarası
200 mm	64208.0100.5012
275 mm	64208.0100.5013
300 mm	64208.0100.5014
1025 mm kes.	64208.0100.5000



F maks 80° = 1800 kN/m



60,5 kg/m



Kalıp giriş parçası 13 mm



V120C/80° H105

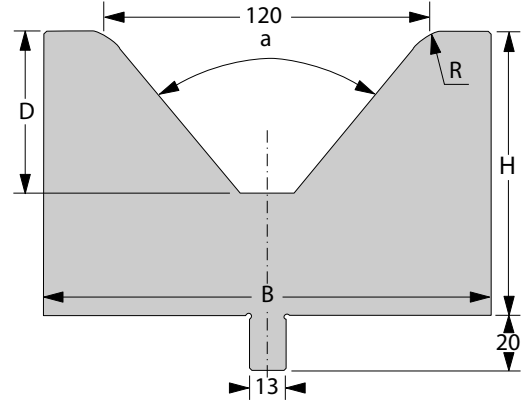
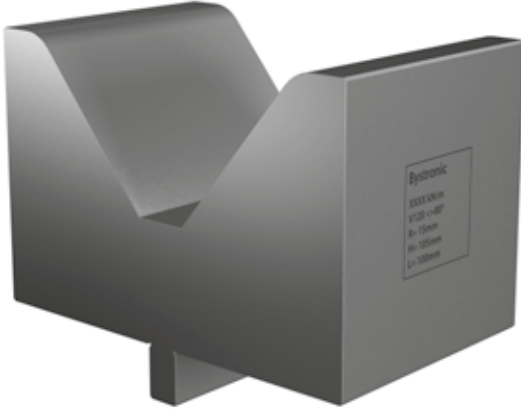

[R] Radyüs (mm)*	15
[a] V - Açısı	80°
[H] Yükseklik (mm)	105

[B] Genişlik (mm)	160
[D] Derinlik (mm)	59,5

*diğer radyüs talep üzerine

Standart uzunluk	Parça numarası
50 mm	64208.0120.5001
55 mm	64208.0120.5002
60 mm	64208.0120.5003
65 mm	64208.0120.5004
70 mm	64208.0120.5005
75 mm	64208.0120.5006
80 mm	64208.0120.5007
85 mm	64208.0120.5008
90 mm	64208.0120.5009
95 mm	64208.0120.5010
100 mm	64208.0120.5011

Standart uzunluk	Parça numarası
200 mm	64208.0120.5012
275 mm	64208.0120.5013
300 mm	64208.0120.5014
1025 mm kes.	64208.0120.5000



F maks 80° = 2000 kN/m



101,0 kg/m



Kalıp giriş parçası 13 mm



V6SC/30° H55

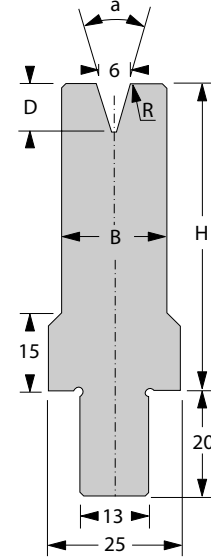

[R] Radyüs (mm)*	0,75
[a] V - Açısı	30°
[H] Yükseklik (mm)	55

[B] Genişlik (mm)	12
[D] Derinlik (mm)	9,3

*diğer radyüs talep üzerine

Standart uzunluk	Parça numarası
50 mm	64208.0006.5101
55 mm	64208.0006.5102
60 mm	64208.0006.5103
65 mm	64208.0006.5104
70 mm	64208.0006.5105
75 mm	64208.0006.5106
80 mm	64208.0006.5107
85 mm	64208.0006.5108
90 mm	64208.0006.5109
95 mm	64208.0006.5110
100 mm	64208.0006.5111

Standart uzunluk	Parça numarası
200 mm	64208.0006.5112
275 mm	64208.0006.5113
300 mm	64208.0006.5114
515 mm	64208.0006.5115
1025 mm kes.	64208.0006.5100



F maks 30° = 100 kN/m



8,1 kg/m



Kalıp giriş parçası 13 mm



V6SC/30° H100

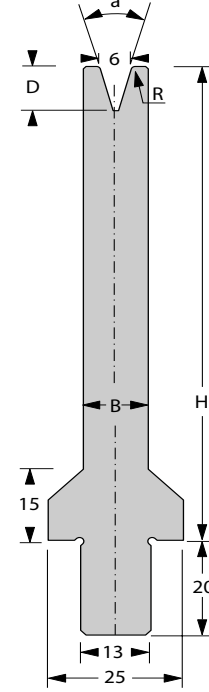

[R] Radyüs (mm)*	0,75
[a] V - Açısı	30°
[H] Yükseklik (mm)	100

[B] Genişlik (mm)	12
[D] Derinlik (mm)	9,3

*diğer radyüs talep üzerine

Standart uzunluk	Parça numarası
50 mm	64208.0006.5151
55 mm	64208.0006.5152
60 mm	64208.0006.5153
65 mm	64208.0006.5154
70 mm	64208.0006.5155
75 mm	64208.0006.5156
80 mm	64208.0006.5157
85 mm	64208.0006.5158
90 mm	64208.0006.5159
95 mm	64208.0006.5160
100 mm	64208.0006.5161

Standart uzunluk	Parça numarası
200 mm	64208.0006.5162
275 mm	64208.0006.5163
300 mm	64208.0006.5164
515 mm	64208.0006.5165
1025 mm kes.	64208.0006.5150



F maks 30° = 100 kN/m



12,3 kg/m



Kalıp giriş parçası 13 mm



V8SC/30° H55

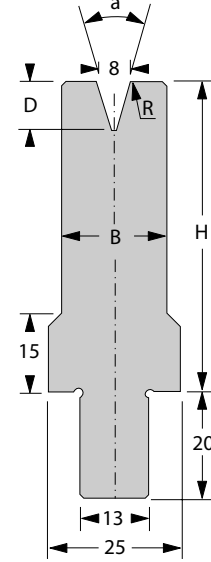

[R] Radyüs (mm)*	1
[a] V - Açısı	30°
[H] Yükseklik (mm)	55

[B] Genişlik (mm)	14
[D] Derinlik (mm)	11,2

*diğer radyüs talep üzerine

Standart uzunluk	Parça numarası
50 mm	64208.0008.5102
55 mm	64208.0008.5103
60 mm	64208.0008.5104
65 mm	64208.0008.5105
70 mm	64208.0008.5106
75 mm	64208.0008.5107
80 mm	64208.0008.5108
85 mm	64208.0008.5109
90 mm	64208.0008.5110
95 mm	64208.0008.5111
100 mm	64208.0008.5112

Standart uzunluk	Parça numarası
200 mm	64208.0008.5113
275 mm	64208.0008.5114
300 mm	64208.0008.5115
515 mm	64208.0008.5116
1025 mm kes.	64208.0008.5100



F maks 30° = 100 kN/m



8,7 kg/m



Kalıp giriş parçası 13 mm



V8SC/30° H100

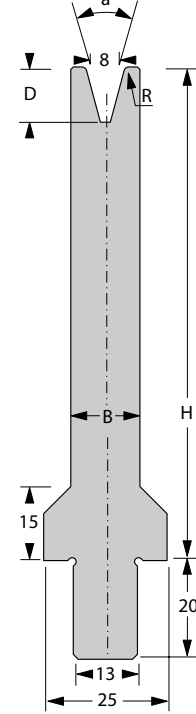

[R] Radyüs (mm)*	1
[a] V - Açısı	30°
[H] Yükseklik (mm)	100

[B] Genişlik (mm)	14
[D] Derinlik (mm)	11,2

*diğer radyüs talep üzerine

Standart uzunluk	Parça numarası
50 mm	64208.0008.5151
55 mm	64208.0008.5152
60 mm	64208.0008.5153
65 mm	64208.0008.5154
70 mm	64208.0008.5155
75 mm	64208.0008.5156
80 mm	64208.0008.5157
85 mm	64208.0008.5158
90 mm	64208.0008.5159
95 mm	64208.0008.5160
100 mm	64208.0008.5161

Standart uzunluk	Parça numarası
200 mm	64208.0008.5162
275 mm	64208.0008.5163
300 mm	64208.0008.5164
515 mm	64208.0008.5166
1025 mm kes.	64208.0008.5150



F maks 30° = 1000 kN/m



13,7 kg/m



Kalıp giriş parçası 13 mm



V10SC/30° H55

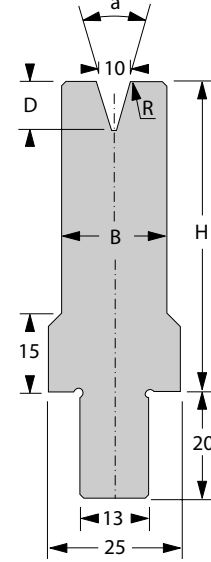

[R] Radyüs (mm)*	1
[a] V - Açısı	30°
[H] Yükseklik (mm)	55

[B] Genişlik (mm)	16
[D] Derinlik (mm)	14,9

*diğer radyüs talep üzerine

Standart uzunluk	Parça numarası
50 mm	64208.0010.5101
55 mm	64208.0010.5102
60 mm	64208.0010.5103
65 mm	64208.0010.5104
70 mm	64208.0010.5105
75 mm	64208.0010.5106
80 mm	64208.0010.5107
85 mm	64208.0010.5108
90 mm	64208.0010.5109
95 mm	64208.0010.5110
100 mm	64208.0010.5111

Standart uzunluk	Parça numarası
200 mm	64208.0010.5112
275 mm	64208.0010.5113
300 mm	64208.0010.5114
515 mm	64208.0010.5115
1025 mm kes.	64208.0010.5100



F maks 30° = 100 kN/m



9,1 kg/m



Kalıp giriş parçası 13 mm



V10SC/30° H100

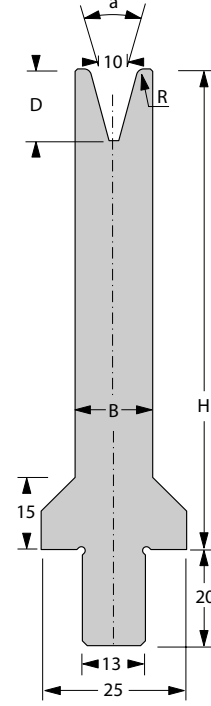

[R] Radyüs (mm)*	1
[a] V - Açısı	30°
[H] Yükseklik (mm)	100

[B] Genişlik (mm)	16
[D] Derinlik (mm)	14,9

*diğer radyüs talep üzerine

Standart uzunluk	Parça numarası
50 mm	64208.0010.5117
55 mm	64208.0010.5118
60 mm	64208.0010.5119
65 mm	64208.0010.5120
70 mm	64208.0010.5121
75 mm	64208.0010.5122
80 mm	64208.0010.5123
85 mm	64208.0010.5124
90 mm	64208.0010.5125
95 mm	64208.0010.5126
100 mm	64208.0010.5127

Standart uzunluk	Parça numarası
200 mm	64208.0010.5128
275 mm	64208.0010.5129
300 mm	64208.0010.5130
515 mm	64208.0010.5131
1025 mm kes.	64208.0010.5116



F maks 30° = 100 kN/m



14,7 kg/m



Kalıp giriş parçası 13 mm



V12SC/30° H55

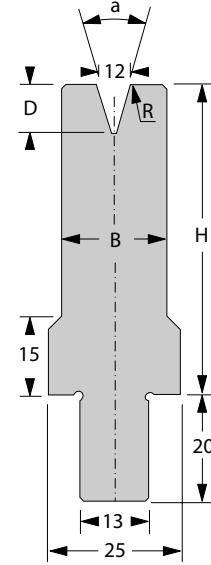

[R] Radyüs (mm)*	1,5
[a] V - Açısı	30°
[H] Yükseklik (mm)	55

[B] Genişlik (mm)	18
[D] Derinlik (mm)	18,6

*diğer radyüs talep üzerine

Standart uzunluk	Parça numarası
50 mm	64208.0012.5101
55 mm	64208.0012.5102
60 mm	64208.0012.5103
65 mm	64208.0012.5104
70 mm	64208.0012.5105
75 mm	64208.0012.5106
80 mm	64208.0012.5107
85 mm	64208.0012.5108
90 mm	64208.0012.5109
95 mm	64208.0012.5110
100 mm	64208.0012.5111

Standart uzunluk	Parça numarası
200 mm	64208.0012.5112
275 mm	64208.0012.5113
300 mm	64208.0012.5114
515 mm	64208.0012.5115
1025 mm kes.	64208.0012.5100



F maks 30° = 100 kN/m



9,5 kg/m



Kalıp giriş parçası 13 mm



V12SC/30° H100

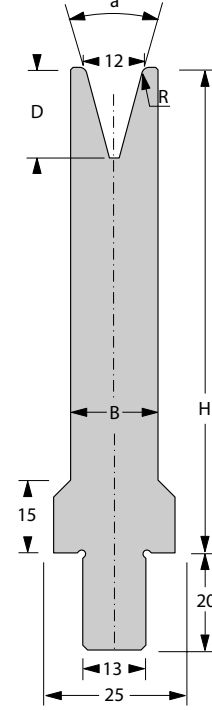

[R] Radyüs (mm)*	1,5
[a] V - Açısı	30°
[H] Yükseklik (mm)	100

[B] Genişlik (mm)	18
[D] Derinlik (mm)	18,6

*diğer radyüs talep üzerine

Standart uzunluk	Parça numarası
50 mm	64208.0012.5117
55 mm	64208.0012.5118
60 mm	64208.0012.5119
65 mm	64208.0012.5120
70 mm	64208.0012.5121
75 mm	64208.0012.5122
80 mm	64208.0012.5123
85 mm	64208.0012.5124
90 mm	64208.0012.5125
95 mm	64208.0012.5126
100 mm	64208.0012.5127

Standart uzunluk	Parça numarası
200 mm	64208.0012.5128
275 mm	64208.0012.5129
300 mm	64208.0012.5130
515 mm	64208.0012.5131
1025 mm kes.	64208.0012.5116



F maks 30° = 100 kN/m



15,9 kg/m



Kalıp giriş parçası 13 mm



Katlama kalıpları

Düzleme kalıpları

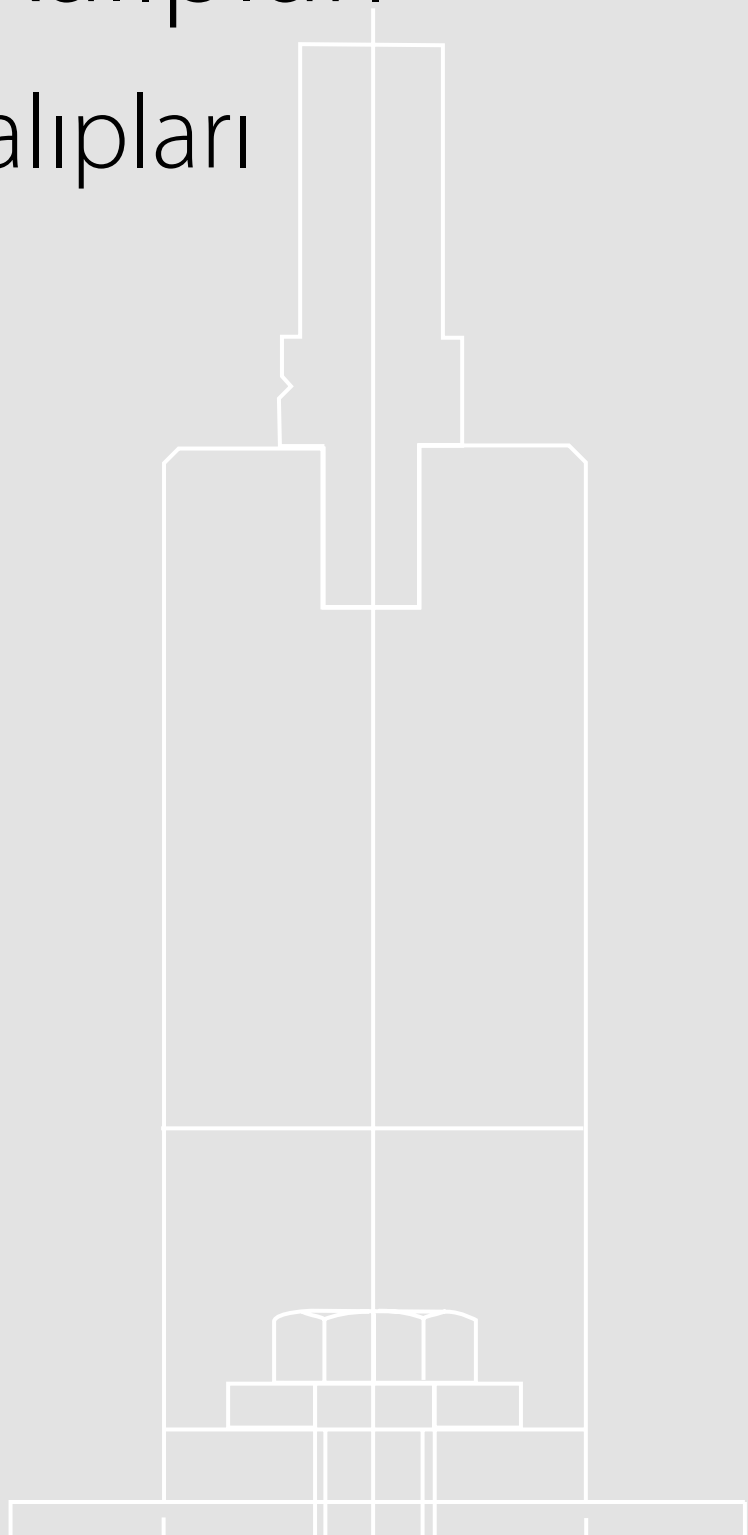





P11 RF-AC H250

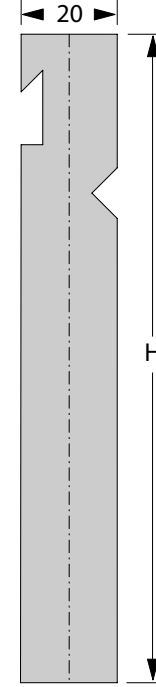

[B] Genişlik (mm)	20
[H] Yükseklik (mm)	250

Standart uzunluk	Parça numarası
30 mm	65208.0011.5001
35 mm	65208.0011.5002
40 mm	65208.0011.5003
45 mm	65208.0011.5004
50 mm	65208.0011.5005
55 mm	65208.0011.5006
60 mm	65208.0011.5007
65 mm	65208.0011.5008
70 mm	65208.0011.5009
75 mm	65208.0011.5010
80 mm	65208.0011.5011

Standart uzunluk	Parça numarası
85 mm	65208.0011.5012
90 mm	65208.0011.5013
95 mm	65208.0011.5014
100 mm	65208.0011.5015
200 mm	65208.0011.5016
275 mm	65208.0011.5017
300 mm	65208.0011.5018
515 mm	65208.0011.5023
1175 mm kes.	65208.0011.5000



F maks = 1400 kN/m



35,9 kg/m



98,0 mm



P900/8 RF-AC/30° H250

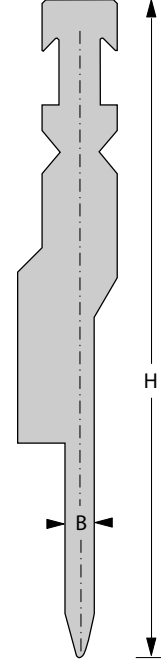

[B] Genişlik (mm) 26,5

[H] Yükseklik (mm) 250

Standart uzunluk	Parça numarası
30 mm	65208.0900.5002
35 mm	65208.0900.5003
40 mm	65208.0900.5004
45 mm	65208.0900.5005
50 mm	65208.0900.5006
55 mm	65208.0900.5007
60 mm	65208.0900.5008
65 mm	65208.0900.5009
70 mm	65208.0900.5010
75 mm	65208.0900.5011
80 mm	65208.0900.5012

Standart uzunluk	Parça numarası
85 mm	65208.0900.5013
90 mm	65208.0900.5014
95 mm	65208.0900.5015
100 mm	65208.0900.5016
200 mm	65208.0900.5017
275 mm	65208.0900.5018
300 mm	65208.0900.5019
515 mm	65208.0900.5020
1175 mm kes.	65208.0900.5000



F maks = 1000 kN/m



29,2 kg/m



P900/10 RF-AC/30° H250

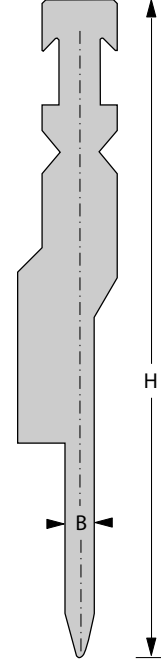

[B] Genişlik (mm) 26,5

[H] Yükseklik (mm) 250

Standart uzunluk	Parça numarası
30 mm	65208.0900.5050
35 mm	65208.0900.5041
40 mm	65208.0900.5042
45 mm	65208.0900.5043
50 mm	65208.0900.5044
55 mm	65208.0900.5045
60 mm	65208.0900.5046
65 mm	65208.0900.5047
70 mm	65208.0900.5048
75 mm	65208.0900.5049
80 mm	65208.0900.5040

Standart uzunluk	Parça numarası
85 mm	65208.0900.5051
90 mm	65208.0900.5052
95 mm	65208.0900.5053
100 mm	65208.0900.5054
200 mm	65208.0900.5055
275 mm	65208.0900.5056
300 mm	65208.0900.5057
515 mm	65208.0900.5058
1175 mm kes.	65208.0900.5059



F maks = 1000 kN/m



29,2 kg/m



P900/12 RF-AC/30° H250

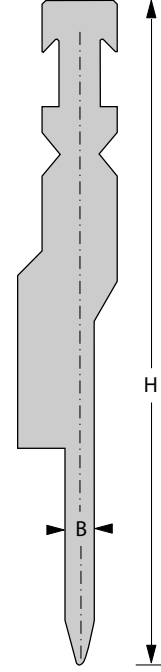

[B] Genişlik (mm)	26,5
[H] Yükseklik (mm)	250

Standart uzunluk	Parça numarası
30 mm	65208.0900.5021
35 mm	65208.0900.5022
40 mm	65208.0900.5023
45 mm	65208.0900.5024
50 mm	65208.0900.5025
55 mm	65208.0900.5026
60 mm	65208.0900.5027
65 mm	65208.0900.5028
70 mm	65208.0900.5029
75 mm	65208.0900.5030
80 mm	65208.0900.5031

Standart uzunluk	Parça numarası
85 mm	65208.0900.5032
90 mm	65208.0900.5033
95 mm	65208.0900.5034
100 mm	65208.0900.5035
200 mm	65208.0900.5036
275 mm	65208.0900.5037
300 mm	65208.0900.5001
515 mm	65208.0900.5038
1175 mm kes.	65208.0900.5039



F maks = 1000 kN/m



34,3 kg/m



V-Flat B40

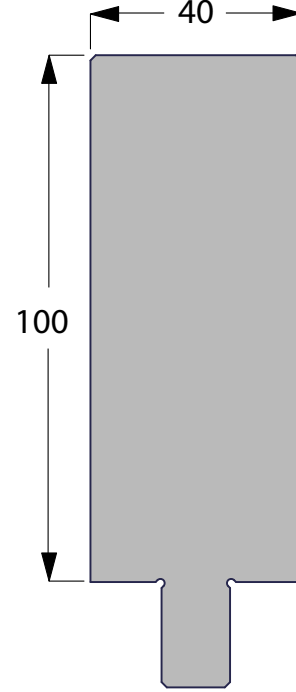

[B] Genişlik (mm) 40

[H] Yükseklik (mm) 100

Standart uzunluk	Parça numarası
50 mm	64208.0000.5001
55 mm	64208.0000.5002
60 mm	64208.0000.5003
65 mm	64208.0000.5004
70 mm	64208.0000.5005
75 mm	64208.0000.5006
80 mm	64208.0000.5007
85 mm	64208.0000.5008
90 mm	64208.0000.5009
95 mm	64208.0000.5010
100 mm	64208.0000.5011

Standart uzunluk	Parça numarası
200 mm	64208.0000.5012
275 mm	64208.0000.5013
300 mm	64208.0000.5014
515 mm	64208.0000.5015
1025 mm kes.	64208.0000.5000



F maks 30° = 2000 kN/m



35,5 kg/m



Kalıp giriş parçası 13 mm



V900/08C

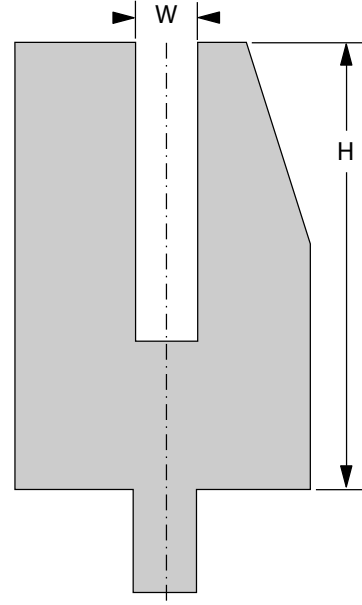

[B] Genişlik (mm) 55

[H] Yükseklik (mm) 85

Standart uzunluk	Parça numarası
50 mm	64208.0900.5003
55 mm	64208.0900.5004
60 mm	64208.0900.5005
65 mm	64208.0900.5006
70 mm	64208.0900.5007
75 mm	64208.0900.5008
80 mm	64208.0900.5009
85 mm	64208.0900.5010
90 mm	64208.0900.5011
95 mm	64208.0900.5012
100 mm	64208.0900.5013

Standart uzunluk	Parça numarası
200 mm	64208.0900.5014
275 mm	64208.0900.5015
300 mm	64208.0900.5002
515 mm	64208.0900.5016
1025 mm kes.	64208.0900.5000



F maks 30° = 250 kN/m



35,5 kg/m



Kalıp giriş parçası 13 mm



V900/10C

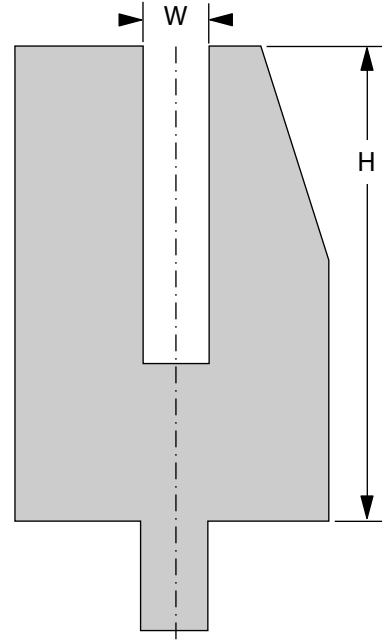

[B] Genişlik (mm) 55

[H] Yükseklik (mm) 85

Standart uzunluk	Parça numarası
50 mm	64208.0900.5032
55 mm	64208.0900.5033
60 mm	64208.0900.5034
65 mm	64208.0900.5047
70 mm	64208.0900.5035
75 mm	64208.0900.5036
80 mm	64208.0900.5037
85 mm	64208.0900.5038
90 mm	64208.0900.5039
95 mm	64208.0900.5040
100 mm	64208.0900.5041

Standart uzunluk	Parça numarası
200 mm	64208.0900.5042
275 mm	64208.0900.5043
300 mm	64208.0900.5044
515 mm	64208.0900.5045
1025 mm kes.	64208.0900.5046



F maks 30° = 250 kN/m



32,0 kg/m



Kalıp giriş parçası 13 mm



V900/12C

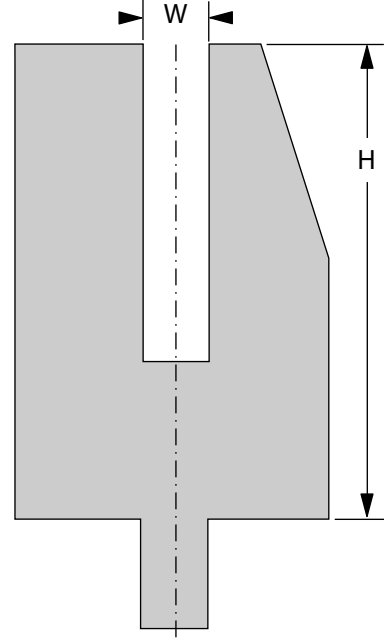

[B] Genişlik (mm) 55

[H] Yükseklik (mm) 85

Standart uzunluk	Parça numarası
50 mm	64208.0900.5017
55 mm	64208.0900.5018
60 mm	64208.0900.5019
65 mm	64208.0900.5020
70 mm	64208.0900.5021
75 mm	64208.0900.5022
80 mm	64208.0900.5023
85 mm	64208.0900.5024
90 mm	64208.0900.5025
95 mm	64208.0900.5026
100 mm	64208.0900.5027

Standart uzunluk	Parça numarası
200 mm	64208.0900.5028
275 mm	64208.0900.5029
300 mm	64208.0900.5001
515 mm	64208.0900.5030
1025 mm kes.	64208.0900.5031



F maks 30° = 250 kN/m



31,0 kg/m



Kalıp giriş parçası 13 mm



Dünya genelinde irtibat bilgileri

Bystronic Laser AG
Industriestrasse 21
3362 Niederönz
İsviçre
Tel. +41 62 956 33 33
E-Posta info.laser@bystronic.com

Bystronic Australia Pty. Ltd.
4 Latchford Street
Cranbourne West VIC 3977
Avustralya
Tel.: +61 1300 975 761
E-Posta info.au@bystronic.com

Bystronic Austria GmbH
Schärdinger Straße 15
4061 Pasching
Avusturya
Tel. +43 7229 64411
E-Posta office.at@bystronic.com

Bystronic do Brasil Ltda.
Rua Parma 203
83413-587 – Colombo – PR
Brezilya
Tel. +55 41 3666 9000
E-Posta bystronic.br@bystronic.com

Bystronic Canada Ltd
3330 Ridgeway Drive, Unit #11
Mississauga, ON L5L 5Z9
Kanada
Tel: +1 905 890 2999
E-Posta sales.canada@bystronic.com

Bystronic (Tianjin) Laser Ltd.
No. 46 Xishi Road
Airport Industrial Park
300308 Tianjin
Çin
Tel: +86 22 5980 1888
E-Posta info.tj.cn@bystronic.com

Bystronic Czech Republic s.r.o.
Turanka 115/1222
627 00 Brno Slatina
Çek Cumhuriyeti
Tel. +420 532 123 314
E-Posta info.cz@bystronic.com

Bystronic Ibérica, S.A.
Avda. Tenerife n° 2
Edificio 1, Planta 3, Oficina D
28700 San Sebastián de los Reyes
(Madrid) España
Tel. +34 91 654 48 78
E-Posta sales.es@bystronic.com

Bystronic France SAS
Parc Technopolis
3, Avenue du Canada
91940 Les Ulis Cedex
Fransa
Tel. +33 1 69 41 99 84
E-Posta info.fr@bystronic.com

Bystronic Maschinenbau GmbH
Mühlhäuser Strasse 3
99867 Gotha
Almanya
Tel. +49 3621 38 30
E-Posta info.bending@bystronic.com

Bystronic Deutschland GmbH
Römerstrasse 14
71296 Heimsheim
Almanya
Tel. +49 7033 46 99 0
E-Posta info.de@bystronic.com

Bystronic Magyarország Kft.
Budaörs Business Center
Puskás Tivadarút 5
2040 Budaörs
Macaristan
Tel: +36 23 610 433
E-Posta info.hu@bystronic.com

Bystronic Laser India (Pvt) Ltd.
7C, Tadiwala Road
Next to Hotel Pancharatna
Pune 411 001
Hindistan
Tel: +91 20 67294800
E-Posta info.in@bystronic.com

Bystronic Italia SRL
Via del Lavoro, 30
20813 Bovisio-Masciago
İtalya
Tel. +39 0362 5993 1
E-Posta sales.it@bystronic.com

Bystronic Japan, Ltd.
2-95-3 Inadaira Musashimurayama-shi
Tokyo 208-0023
Japonya
Tel: +81 42 506 8271
E-Posta Cesar.Mujica@bystronic.com



■ Geliştirme ve üretim yerleri
■ Satış ve servis sağlayıcılar



Bystronic Laser Pte. Ltd.

(Temsilci Ofis)
Level 8, MCT Tower, Sky Park,
One City, Jalan USJ 25/1
Subang Jaya
47650 Selangor
Malezya
Tel: +60 3 8022 8268

Bystronic Mexico S.A. de C.V.

Helios 401 A, Parque Industrial FINSA
Apodaca
66600 Nuevo León
Meksika
Tel. +52 81 2133 7600
E-Posta sales.mexico@bystronic.com

Bystronic Benelux B.V.

Duurzaamheidsring 11
4231 EX Meerkerk
Hollanda
Tel. +31 184 611 020
E-Posta sales.benelux@bystronic.com

Bystronic Korea, Ltd.

3F Bystronic Bldg,
32-18, LS-ro
91 Beon-gil, Dongan-gu Anyang-si
14119 Gyeonggi-do
Kore
Tel. +82 31 389 9800
E-Posta info.kr@bystronic.com

Bystronic Polska Sp. z o.o.

Ul. Sokolowska 47
PL-05-806 Sokolów
Polonya
Tel. +48 22 331 37 70
E-Posta info.pl@bystronic.com

S.C. Bystronic Laser S.R.L.

Str. Poienelor no. 5
Industrial Pro Roman Park
500419 Brasov
Romanya
Tel: +40 268 322 140
E-Posta info.ro@bystronic.com

Bystronic Laser

Zorge Street, 9A
Stroenie 2 (Building 2)
125252 Moskova
Rusya
Tel: +7 495 984 71 44
E-Posta info.ru@bystronic.com

Bystronic Co., Ltd. (Shanghai)

Room 602, Part A,
No. 388 North Fu Quan Road
Changning District
Shanghai, 200335
Tel. +86 21 6082 9300
E-Posta info.sha.cn@bystronic.com

Bystronic Pte. Ltd.

Thye Hong Centre
2 Leng Kee Road #02-04
159086 Singapur
Tel. +65 6472 6300
E-Posta info.sg@bystronic.com

Bystronic Scandinavia AB

Metallvägen 30A
195 72 Rosersberg
İsveç
Tel: +46 (0)8 594 415 50
E-Posta Services.SE@bystronic.com

Bystronic Sales AG

Industriestrasse 21
3362 Niederönz
İsviçre
Tel. +41 62 956 37 83
E-Posta info.sales@bystronic.com

Bystronic International Laser Ltd.

No. 66, Wuquan Rd.,
Wugu Dist.,
New Taipei City 248
Tayvan (R.O.C)
Tel: +886 2 2299 2699
E-Posta hotline.tw@bystronic.com

Bystronic Lazer ve Su Isinlari

Makineleri Sanayi ve Ticaret Ltd. Sti.
Serifali Mevkii, Barbaros Caddesi
No: 66 K:1
34775 Ümraniye/İstanbul
Türkiye
Tel: +90 216 464 6160
E-Posta info.tr@bystronic.com

LLC Bystronic Ukraine

59 Zhylyanskaya Street
Diplomat Hall, 2nd floor, Office 207
1033 Kyiv
Ukrayna
Tel. +380 44 569 74 37
E-Posta info.cis@bystronic.com

Bystronic UK Ltd.

6 Wayside Business Park
Wilson's Lane
Coventry
Warwickshire CV6 6NY
İngiltere
Tel: +44 (0)844 848 5850
E-Posta sales.uk@bystronic.com

Bystronic Inc.

2200 West Central Road
US-Hoffman Estates
IL 60192
ABD
Tel. +1 847 214 0300
E-Posta sales.us@bystronic.com

Bystronic Vietnam Co. Ltd.

38/7 Truong Chinh Str.
Tan Thoi Nhat Ward
District 12
Hochiminh City
Vietnam
Tel: +84 28 3719 2278
E-Posta Anh Tuan.Ha@bystronic.com

