

Technical Data

Xpert Pro

	Xpert Pro Extended 100/3100 + Modular Tool Changer	Xpert Pro Extended 150/3100 + Modular Tool Changer	Xpert Pro Extended 200/3100 + Modular Tool Changer	Xpert Pro Extended 200/4300 + Modular Tool Changer	Xpert Pro Extended 250/3100 + Modular Tool Changer	Xpert Pro Extended 250/4300 + Modular Tool Changer	Xpert Pro Extended 320/4300 + Modular Tool Changer	
Length	5780	5780	5780	6980	5780	6980	6980	mm
Width	4940	4940	4940	4940	4940	4940	4940	mm
Height	3420	3420	3660	3660	3660	3660	3750	mm

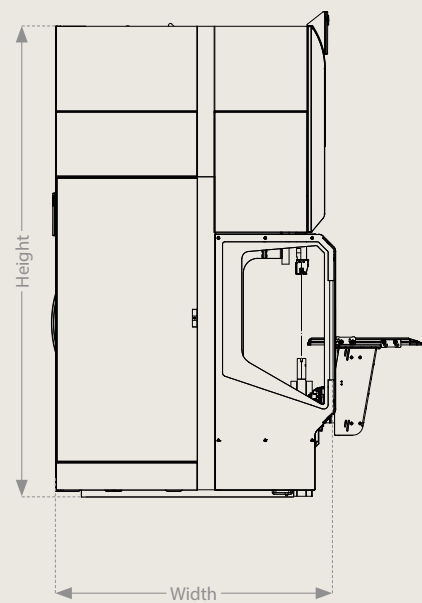
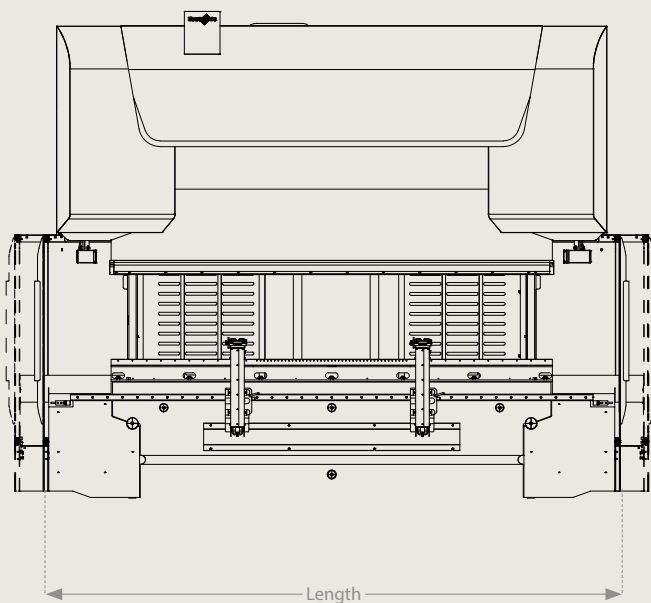

Type	Xpert Pro 100/3100	Xpert Pro 150/3100	Xpert Pro 200/3100	Xpert Pro 200/4300	Xpert Pro 250/3100	Xpert Pro 250/4300	Xpert Pro 320/4300	
Tonnage	1000	1500	2000	2000	2500	2500	3200	kN
Bending length	3100	3100	3100	4300	3100	4300	4300	mm
Standard stroke (S)	250	250	250	250	250	250	250	mm
Open height (D)	640	640	640	640	640	640	640	mm
Distance between side frames	2750	2750	2750	3750	3750	3750	3750	mm
Throat (T)	400	400	400	400	400	400	400	mm
Table Width	60	60	60	60	60	60	60	mm
Max. back gauge range X-axis (2/4/5-axis)	1050	1050	1050	1050	1050	1050	1050	mm
X-axis travel (2/4/5-axis)	600	600	600	600	600	600	600	mm
X-axis speed for 2/4/5-axis (up to)	650	650	650	650	650	650	650	mm/s
X-axis accuracy (2/4/5-axis)	0,04	0,04	0,04	0,04	0,04	0,04	0,04	mm
R-axis travel (2/4/5-axis)	250	250	250	250	250	250	250	mm
R-axis speed for 2/4/5-axis (up to)	200	200	200	200	200	200	200	mm/s
R-axis accuracy (2/4/5-axis)	0,1	0,1	0,1	0,1	0,1	0,1	0,1	mm
Z-axis travel	1900	1900	1900	2900	1900	2900	2900	mm
Z-axis speed for 4/5-axis (up to)	1500	1500	1500	1500	1500	1500	1500	mm/s
Z-axis speed for 6-axis (up to)	1200	1200	1200	1200	1200	1200	1200	mm/s
Z-axis accuracy (4/5-axis)	0,1	0,1	0,1	0,1	0,1	0,1	0,1	mm
Accuracy Y-axis	0,004	0,004	0,004	0,004	0,004	0,004	0,004	mm
Oil capacity	300	300	450	450	450	450	600	l
Electric supply (Classic, Performance edition)	15	19	22	22	26	26	34	kW
Electric supply (Dynamic edition)	19	22	26	26	34	34	41	kW
Weight	11	11	17,5	21	17,5	21	25	t
Proposed foot print approx. (L x W x H)								
Lenght	6000	6000	6000	7000	6000	7000	7000	mm
Width	4500	4500	4500	4500	4500	4500	4500	mm
Height	3400	3400	3600	3600	3600	3600	3600	mm

The right to make changes to dimensions, construction, and equipment is reserved. ISO-9001-certified.

The technical data can vary in the different countries,
according to the security rules and the chosen configuration of the machine.

Type	Xpert Pro Extended 100/3100	Xpert Pro Extended 150/3100	Xpert Pro Extended 200/3100	Xpert Pro Extended 200/4300	Xpert Pro Extended 250/3100	Xpert Pro Extended 250/4300	Xpert Pro Extended 320/4300	
Tonnage	1000	1500	2000	2000	2500	2500	3200	kN
Bending length	3100	3100	3100	4300	3100	4300	4300	mm
Standard stroke (S)	450	450	450	450	450	450	450	mm
Open height (D)	840	840	840	840	840	840	840	mm
Distance between side frames	2750	2750	2750	2750	2750	2750	2750	mm
Throat (T)	400	400	400	400	400	400	400	mm
Table Width	60	60	60	60	60	60	60	mm
Max. back gauge range X-axis (2/4/5-axis)	1050	1050	1050	1050	1050	1050	1050	mm
X-axis travel (2/4/5-axis)	600	600	600	600	600	600	600	mm
X-axis speed for 2/4/5-axis (up to)	650	650	650	650	650	650	650	mm/s
X-axis accuracy (2/4/5-axis)	0,04	0,04	0,04	0,04	0,04	0,04	0,04	mm
R-axis travel (2/4/5-axis)	250	250	250	250	250	250	250	mm
R-axis speed for 2/4/5-axis (up to)	200	200	200	200	200	200	200	mm/s
R-axis accuracy (2/4/5-axis)	0,1	0,1	0,1	0,1	0,1	0,1	0,1	mm
Z-axis travel	1900	1900	1900	1900	1900	1900	1900	mm
Z-axis speed for 4/5-axis (up to)	1500	1500	1500	1500	1500	1500	1500	mm/s
Z-axis speed for 6-axis (up to)	1200	1200	1200	1200	1200	1200	1200	mm/s
Z-axis accuracy (4/5-axis)	0,1	0,1	0,1	0,1	0,1	0,1	0,1	mm
Accuracy Y-axis	0,004	0,004	0,004	0,004	0,004	0,004	0,004	mm
Oil capacity	300	300	450	450	450	450	600	l
Electric supply (Classic, Performance edition)	15	19	22	22	26	26	34	kW
Electric supply (Dynamic edition)	19	22	26	26	34	34	41	kW
Weight	13	13	20.5	23.5	20.5	23.5	28	t
Proposed foot print approx. (L x W x H)								
Lenght	6000	6000	6000	7000	6000	7000	7000	mm
Width	4500	4500	4500	4500	4500	4500	4500	mm
Height	4000	4000	4100	4100	4100	4100	4200	mm

The right to make changes to dimensions, construction, and equipment is reserved. ISO-9001-certified.

The technical data can vary in the different countries,
according to the security rules and the chosen configuration of the machine.